

LUB-S

User manual LUB-S-B (battery)



GRUETZNER
AUTOMATIC LUBRICATION

I. Revision history & imprint

I.I Revision history

The present user manual is the original user manual.

This user manual is only valid for

Product:

Product designation: Lubricus S-B (LUB-S-B)
 Product revision: ---

User manual:

Date of creation: 10.2019
 Revision of the user manual: 2

This document is protected by copyright.

All rights for layout, content, texts and corporate design are reserved by Gruetzner GmbH, © 2019.

All rights, including those of photomechanical reproduction, duplication and distribution by means of special processes (e.g. data processing, data carriers and data networks), even in part and/or in extracts, are reserved by Gruetzner GmbH.

The content and technical specifications are subject to change without notice.

Revision	Date	Description
2	10.2019	Updated: <ul style="list-style-type: none"> ▪ Adjustment of the software parameter Dispensing time h ↻ Chapter 6.3.1, Chapter. 6.3.8
1	09.2019	Basic Version

I.II Imprint

Adress:

Gruetzner GmbH
 Dagobertstr. 15
 90431 Nuremberg, Germany
 Tel: +49 (0)911 277 399-0
 Fax: +49 (0)911 277 399-99
 info@G-LUBE.com
 www.G-LUBE.com

Commercial Register of Nuremberg Local Court: HRB 12109

USt.-ID: DE 160441123

CEO: Volker Grütznert

I.II Table of contents

Chapter	Content	Page
I.	Revision history & imprint	02
I.I	Revision history	02
I.II	Imprint of the manufacturer, distribution and service	02
I.III	Table of contents	03
1.	General information about this manual	05
1.1	Signal words	05
1.2	Warning symbols	06
1.3	Structure of safety instructions	06
1.4	Symbols for information	06
2.	Safety	07
2.1	EC/EU Directive	07
2.2	Hazards	07
2.3	Staff	07
2.4	Reasonably predictable misuse	07
2.5	Usage for the intended purpose	08
2.6	Warranty and Liability	08
2.7	General safety instructions	09
3.	Description of function	10
3.1	General information	10
3.2	Nameplate and designation	11
3.3	Scope of delivery	11
3.4	Technical data	12
4.	Transport and storage	13
4.1	Packaging	13
4.2	Transport	13
4.3	Storage	13
5.	Mounting	14
5.1	Preparations	14
5.2	Assembly	14
5.3	Commissioning	17

Chapter	Content	Page
6.	Operation and settings	18
6.1	General information	18
6.2	Factory settings	19
6.2.1	Default settings, operating mode: hour mode -h-	19
6.2.2	Default settings, operating mode: empty time mode Et	20
6.3	Menu and LCD messages	21
6.3.1	LCD	24
6.3.2	Actions with the activation and programming key	27
6.3.3	Switching on and off	29
6.3.4	INF menu, operating mode: hour mode -h-	30
6.3.5	INF menu, operating mode: empty time mode Et	31
6.3.6	SET menu	32
6.3.7	RUN menu	34
6.3.8	PRO menu, operating mode: hour mode -h-	35
6.3.9	PRO menu, operating mode: empty time mode Et	38
6.3.10	FIL menu	40
6.4	Error messages	41
7.	Maintenance and disposal	42
7.1	Maintenance schedule	42
7.1.1	Visual check	43
7.1.2	Cleaning	43
7.1.3	Recommissioning after maintenance	43
7.2	Cartridge and battery change	44
7.3	Disposal	48
8.	Released accessories	49
8.1	Lubricants	50
8.2	Tube lengths	50
9.	Appendix	51
9.1	Dimension sheet and installation dimensions	51
9.2	EC/EU Declaration of conformity	52
9.3	Spare parts	53

1. General information about this manual

This user manual contains all necessary information to use Lubricus S-B (battery version), hereinafter referred to as LUB-S-B, safely and as intended. In the event that supplementary sheets are attached to these instructions, the information and data contained there are valid and replace the corresponding information in this user manual. Any contradictory information contained in this user manual thus becomes invalid. If you have any questions regarding special applications, please contact Gruetzner GmbH (chapter I.II).

The actual and factual operator must ensure and guarantee that these instructions, including any supplementary sheets, have been read and understood by all persons responsible for the installation, operation or maintenance of LUB-S-B. Therefore, keep these instructions in a suitable place, ideally in an easily accessible place in the surrounding area of LUB-S-B.

Inform your colleagues who work in the local area of the machine about safety instructions so nobody gets hurt.

This manual was written in German, all other language versions are translations of this manual.

1.1 Signal words

The following signal words are used in this manual to draw your attention to possible dangers, prohibitions and other important information:

DANGER

This signal word points you to an immediate and threatening risk of serious injury or death.

WARNING

This signal word indicates a potentially imminent danger which can result in serious injury or even death.

CAUTION

This signal word indicates a potentially imminent danger that can result in minor to severe injuries.

NOTICE



This signal word indicates a potentially imminent danger which can result in damage to property.

INFORMATION

This signal word refers to practical application tips or particularly important information when using LUB-S-B.

1.2 Warning symbols

The following warning symbols are used in this user manual to alert you to hazards, prohibitions and important information:

		
General warning sign	Electricity hazard	Flammable material



1.3 Structure of the safety instructions

The safety instructions in this user manual are structured according to the following system:

	CAUTION
	<p>This text explains the consequences of disregarding the reference.</p> <p>This text shows what to do as an instruction.</p>

1.4 Symbols for information

The following information symbols are used in the text and instructions in this manual:

-  Requests you to take action
-  Shows the consequences of an action
-  Additional information about the action

2. Safety

All persons working with LUB-S-B must follow these operating instructions, in particular the safety instructions and the rules and regulations applicable at the place of use. Generally applicable legal regulations and other rules as well as the relevant rules and regulations for accident prevention (e.g. personal protective equipment (PPE)) and environmental protection must be observed.

2.1 EC/EU Directive

Within the scope of the EC/EU Directive, (re)commissioning of a machine on which LUB-S-B has been installed and/or fitted is prohibited until it has been clearly established that the machine complies with the provisions of the applicable directive. An EC/EU declaration of conformity for LUB-S-B can be found in the appendix (chapter 9.2).

2.2 Hazards

In order to avoid danger to the user or damage to the machine on which LUB-S-B is used, LUB-S-B may only be used for its intended purpose (chapter 2.5) and in a technically safe condition.

Always inform yourself about the general safety instructions (chapter 2.7) before starting to work.

2.3 Staff

Only qualified staff who has read and understood this manual may work with LUB-S-B. Local and/or company regulations apply accordingly.

2.4 Reasonably predictable misuse

Any use of LUB-S-B which exceeds the maximum permissible technical data is generally considered to be improper and therefore prohibited.

3.2 Usage for the intended purpose

The following points must be observed for the intended purpose of using LUB-S-B:

- LUB-S-B is exclusively approved for industrial use.
- LUB-S-B may be used in accordance with the technical data (chapter 3.4) exclusively.
- Unauthorized structural alterations to LUB-S-B are not permitted.
- Read the user manual and act accordingly.
- During operation of LUB-S-B, a visual inspection of LUB-S-B as well as of the lubrication point must be carried out regularly. Any anomalies must be eliminated immediately and the cause must be rectified.
- Refilling the cartridge is not permitted.
- LUB-S-B may not be opened or disassembled.
- Only lubricants approved by the manufacturer may be used.
- Relevant regulations and rules on work safety, accident prevention and environmental protection must be observed.
- Work and activities with and on LUB-S-B are only permitted with appropriate authorisation (chapter 2.3).

All other uses than the aforementioned intended usage or the disregard of one of the above points shall be deemed improper usage. In this case no liability and/or warranty is assumed.





3.3 Warranty and Liability

If the following items are disregarded, all warranty and liability claims for personal injury and/or damage to property are excluded:

- non-observance of the instructions on transport and storage;
- misuse;
- improper or unperformed maintenance or repair work;
- improper assembly / disassembly or improper operation;
- operation of LUB-S-B with defective protective devices;
- operation of LUB-S-B without lubricant;
- operation of LUB-S-B with non-approved lubricant;
- operation of heavily contaminated LUB-S-B;
- modifications or alterations which may be carried out without the written permission of Gruetzner GmbH have taken place;
- opening and/or partial or complete disassembly of LUB-S-B.

3.4 General safety instructions

The following safety instructions are given for LUB-S-B:

	<p style="text-align: center;">NOTICE</p> <p>Loose or overloaded screw connections can cause damage to LUB-S-B.</p> <ul style="list-style-type: none"> • Mount and check all screw connections with the permissible torques specified for this purpose. Use a calibrated torque wrench.
	<p style="text-align: center;">WARNING</p> <p>Lubricants are flammable.</p> <ul style="list-style-type: none"> • In case of fire do not use a water jet to extinguish. • In case of fire only use suitable extinguishing agents such as powder, foam and carbon dioxide. • Observe the relevant safety instructions of the lubricant manufacturer on the safety data sheet of the lubricant used.
	<p style="text-align: center;">CAUTION</p> <p>Lubricants can cause skin irritations.</p> <ul style="list-style-type: none"> • Avoid direct skin contact.
	<p style="text-align: center;">NOTICE</p> <p>Lubricants can contaminate soil and water.</p> <ul style="list-style-type: none"> • Use and dispose lubricants properly.

4. Description of function

4.1 General information

LUB-S-B is designed as an extremely compact double piston pump for autonomous operation with lubricants. The two pistons run force-controlled and counter-rotating. They are united into one outlet. The outlet is secured by an integrated non-return valve. Approx. 0.16 cm³ of lubricant is pumped during each dispensing operation; multiple dispenses can be set one after the other. The LCD on the front panel displays the various operating states; further information (empty cartridge, error) can be read.

The present Lubricus S-B as battery version has no electrical interface. The supplied activation and programming key can be used to adjust the operating mode and the quantity of lubricant pumped per time to supply the lubrication point with the ideal quantity of lubricant.

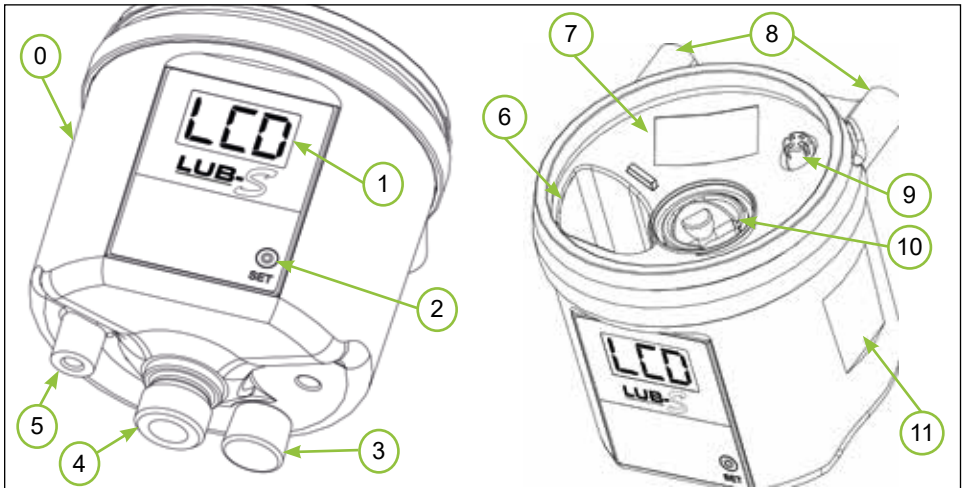

Fig. 1: Overview LUB-S-B

No.	Description
0	LUB-S-B
1	LCD
2	Operation pad (for actions with the activation and programming key)
3	Activation and programming key
4	Lubricant outlet / M16 male thread for bottom mounting
5	M5 female thread for bottom mounting
6	Battery compartment
7	Serial number of LUB-S-B
8	M5 female thread for rear mounting
9	Cartridge sensor
10	Lubricant inlet with thread for cartridge
11	Nameplate with designation and CE mark

4.2 Nameplate and designation

The nameplate of LUB-S-B is visibly attached to the side of the pump itself. There the CE mark and the serial number of LUB-S-B are visible. Refer to chapter 3, Fig. 1 for the location of the nameplate and serial number.

4.3 Scope of delivery

LUB-S-B is available in several different versions. They differ in the number of accessories supplied.

All versions of LUB-S-B are prefilled with a neutral, food-grade (H1) lubricant (approx. 3 cm³), which can be mixed with the lubricants approved by Gruetzner GmbH, to simplify the initial commissioning. The manufacturer's designation is Total Ceran FG. Further data and documentation on the lubricant Total Ceran FG are available on request from Gruetzner GmbH.

4.4 Technical data

Housing			
dimensions without cartridge	width x height x depth	83 x 82 x 85	mm
dimensions with cartridge		83 x 152 x 85	
weight (without cartridge)	appx.	350	g
mounting options		backside: female thread M5 (2x) bottom: female thread M5 (1x) bottom: male thread M16x1,5 (1x)	
max. torque mounting		3	Nm
mounting position		any, upright (preferred)	
material housing		PA 6.6 GF30 / POM	
material outlet		stainless steel	
operating temperature		alkaline battery: +15 ... +60 lithium battery: -15 ... +60	°C
Lubricant and hydraulic			
cartridge volume		125	ml
lubricant characteristics		oils and greases up to NLGI 2	
number of outlets		1	
hydraulic connection		directly or via PA tube	
number of lubrication points		1	
max. pressure		35 (-10%/+15%)	bar
grease delivery	per stroke	0.16 (-5%)	cm ³
Electrics			
display		LCD	
operating voltage		4.5	V
protection		-	A
protection class		IP 54	

5. Transport and storage

5.1 Packaging

LUB-S-B is delivered in an outer packaging (cardboard box) and - depending on the scope of delivery - with a lubricant cartridge and other accessories in the same package. To protect them from moisture and dirt they are also packed in PE films.

To prevent the escape of the prefilled lubricant from LUB-S-B, appropriate protective caps are fitted into the lubricant supply and the lubricant outlet. Dispose the packaging materials at designated disposal points in compliance with the relevant national and company regulations.

After receiving LUB-S-B check the delivery note for completeness and correctness. Any missing parts or damages must be reported immediately to the forwarding agent, the insurance company or Gruetzner GmbH in writing.

5.2 Transport

NOTICE	
	<p>Hard shocks due to e.g. falling or setting down too hard can damage LUB-S-B.</p> <ul style="list-style-type: none"> • Do not throw LUB-S-B. • When using lifting equipment only use hoists and load handling attachments in perfect condition and with sufficient load capacity. • The permissible lifting weight of the lifting device must not be exceeded.

5.3 Storage

Store LUB-S-B in its original packaging in a vertical position in a dry, frost-free environment at an ambient temperature of +5 °C to +30 °C. The maximum storage time in unopened condition is 2 years.

The so-called "first-in-first-out" principle (fifo) is recommended for storage logistics.

6. Mounting

6.1 Preparations

Before starting to work, inform yourself in detail about LUB-S-B using this user manual; and follow the general safety instructions (section 2.7) in particular. Prepare the installation site carefully.

	NOTICE
	<p>Pressurised air can damage the seals of LUB-S-B and can transport dirt and foreign matter into LUB-S-B or the lubricant.</p> <ul style="list-style-type: none"> • Do not use pressurised air. • Make sure that there is no coarse dirt in the mounting area.

6.2 Assembly

1	<p>Condition as delivered</p> <p>LUB-S-B is delivered in a cardboard box. Depending on the version ordered further accessories such as battery, lubricant cartridge or additional tube connection parts are included. It also contains a short manual for experienced users to start up and assemble the unit for the first time.</p>
---	--

2	<p>Remove protective cap from the top of LUB-S-B</p> <p>✦ Remove the yellow protective cap from the top of the lubricant inlet of LUB-S-B.</p> <p>ⓘ Make sure that no dirt, water or foreign bodies enter the lubricant inlet.</p>
---	---



3

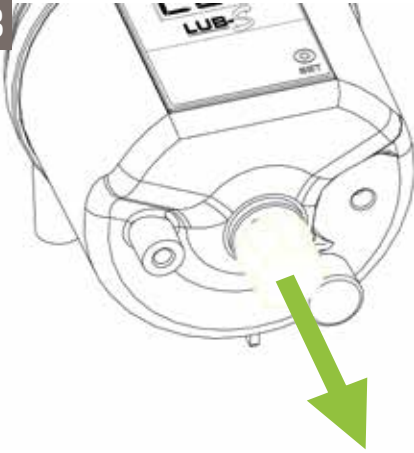

Remove protective cap from the bottom of LUB-S-B

- ✦ Unscrew the yellow protective cap counterclockwise from the bottom of the lubricant outlet of LUB-S-B.

4

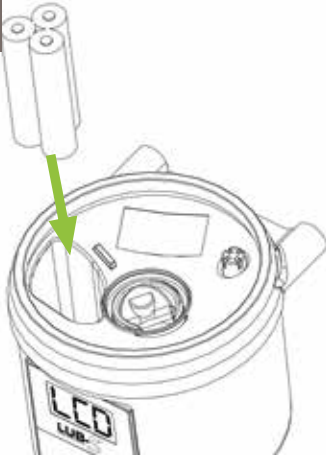

Insert battery

- ✦ Extract the battery cable from the battery compartment.
- ✦ Connect the battery to the battery cable using the plug.
- ✦ Store the battery and the battery cable in the battery compartment.

- ⓘ Make sure that the battery cable or plug does not protrude from the battery compartment.

5

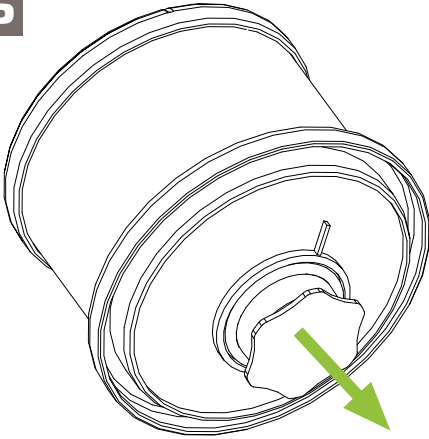

Unscrew cartridge cap

✦ Turn the cap on the lubricant cartridge counterclockwise and pull it off.

ⓘ Pay attention to cleanliness when working. It is imperative that dirt and foreign bodies do not enter the cartridge.

6



Mount lubricant cartridge

✦ Place the full lubricant cartridge on LUB-S-B.

✦ Turn the lubricant cartridge clockwise onto LUB-S-B.

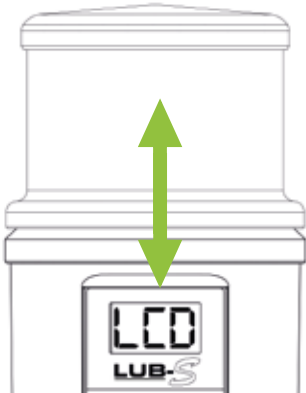

ⓘ The end position is reached after two full rotations when the label of the lubricant cartridge is aligned with the front label of LUB-S-B.

6.3 Commissioning

Mount LUB-S-B carefully according to the steps described in chapter 5.2. Depending on the scope of delivery, you must also carry out the following additional measures for first-time commissioning:

1. Mechanical fastening

Fix LUB-S-B mechanically through the M5 female threads or through the M16x1.5 male thread of the lubricant outlet. Pay particular attention to the maximum tightening torques permissible for the M5 female threads!

2. Check the assembly

Make sure that LUB-S-B is properly and completely assembled. In particular, the battery must be inserted and a lubricant cartridge must be fitted.

3. Power on

If you want to put LUB-S-B into operation, switch on LUB-S-B. LUB-S-B only delivers lubricant to the lubrication point according to the settings when switched on. The detailed description for powering on can be found in chapter 6.3.3.

4. Execute FIL function

Execute the FIL function. The detailed description can be found in chapter 6.3.10. LUB-S-B performs a certain number of strokes and transports lubricant from the cartridge to the outlet.

5. Hydraulic connection

Connect the consumer hydraulically to LUB-S-B. If you connect tubes to LUB-S-B make sure that tubes and connectors are installed tightly, cleanly and correctly.

📌 Ideally, use tubes prefilled with the appropriate lubricant.

6. Check the settings on LUB-S-B

Check the required values for the lubrication point at the factory settings of LUB-S-B and adjust them if necessary. The factory settings are recorded in chapter 6.2; changes at LUB-S-B can be made in the SET menu, chapter. 6.3.6, and in the PRO menu, chapter 6.3.8 to 6.3.9.

7. Operation and settings

7.1 General information

What you should know about operating and setting LUB-S-B:

✓ LUB-S-B is designed as a single point lubricator for one lubrication point. Accessories from the manufacturer can be connected to LUB-S-B. If necessary, changes must be made to the settings to ensure a safe and reliable operation.

✓ LUB-S-B is a cycle-controlled lubricant dispenser which operates autonomously and time-based via the integrated microelectronics. LUB-S-B cyclically delivers a defined quantity of lubricant from the cartridge to the outlet. Two operating modes can be selected. The **hour mode -h-** allows setting the number of cycles (c) within a dispensing time (h) in hours. The cycles (c) are evenly distributed over the dispensing time. Dispensing times (h) between 1...99 hour(s) and cycles (c) between 1...10 can be set.

The **empty time mode Et** allows the emptying time of the cartridge to be set in months. Emptying times between 1...24 month(s) can be set.

✓ The disposable, interchangeable cartridge containing 125 ml lubricant guarantees a controlled and constant quality of the lubricant and is filled bubble-free. LUB-S-B allows a high supply security of the lubrication point and prevents failures.

✓ LUB-S-B cannot be used without a lubricant cartridge and suitable battery. Both - depending on the version ordered - can already be included in the scope of delivery and may already be connected and installed in LUB-S-B.

✓ The alkaline battery is suited for the operation under normal operating conditions. To meet high requirements, use the more powerful lithium battery.

✓ The respective conditions of LUB-S-B can be seen in the LCD. It additionally enables the optical recognition of the condition by means of coloured LEDs.

✓ If you have any questions about your application and the correct settings for LUB-S-B, please contact the manufacturer (chapter I.II).

7.2 Factory settings

LUB-S-B is always delivered with the following factory settings:

operating mode:	hour mode -h-	
mode:	OFF	LUB-S-B is switched off

① The factory settings provide the use of LUB-S-B in hour mode -h-. If you would like to operate LUB-S-B in empty time mode Et, you have to make changes in the SET menu of LUB-S-B (chapter 6.3.6).

7.2.1 Default settings, operating mode: hour mode -h-

Dispensing time	h = 6	The dispensing time is 6 hours.
Number of cycles	c = 1	The number of cycles is one (1) stroke during the dispensing time.

① The default settings in hour mode result in an emptying time (service life) of 195 days (= 6.4 months) for a full 125 ml lubricant cartridge, provided that the LUB-S-B is permanently switched on and no special dispensations have been made. Within approx. 6 hours, LUB-S-B will deliver one dispense per stroke (0.16 cm³).

✦ Verify that the default settings are appropriate for your application and that the lubrication point is supplied with the correct amount of lubricant per time unit. If this is the case, you can operate LUB-S-B with the default settings in hour mode -h-.

If this is **not** the case change the values for the dispensing time h and number of cycles c accordingly; see chapter 6.3.8 for an explanation of how to make these changes.

① To use LUB-S-B it must be properly mounted and installed first and then switched on. The installation is very simple and is described in detail in chapter 5.2; switching on is described in chapter 6.3.3.

① If you order a factory-provided special version of LUB-S-B, the information contained in the supplement is authoritative.

7.2.2 Default settings, operating mode: empty time mode Et

Emptying time $E_t = 6$ The emptying time of one (1) cartridge is 6 months.

ⓘ The default settings in empty time mode result in an emptying time (service life) of 6 months for a full 125 ml lubricant cartridge, provided that LUB-S-B is permanently switched on and no special dispensations have been made. Within approx. 5.6 hours, LUB-S-B will deliver one dispense per stroke (0.16 cm³).

✦ Verify that the default settings are appropriate for your application and that the lubrication point is supplied with the correct amount of lubricant per time unit. If this is the case, you can operate LUB-S-B with the default settings in empty time mode Et.

If this is **not** the case, change the values for the emptying time t accordingly; see chapter 6.3.9 for an explanation of how to make these changes.

ⓘ To use LUB-S-B, it must first be properly mounted and installed and then switched on. The installation is very simple and is described in detail in chapter 5.2; switching on is described in chapter 6.3.3.

ⓘ If you order a factory-provided special version of LUB-S-B, the information contained in the supplement is authoritative.



7.3 Menu and LCD messages

The LCD of LUB-S-B can be used to read information, to change settings with the activation and programming key on the underside of LUB-S-B or to trigger individual actions.

Generally, settings can be changed and actions can be triggered when LUB-S-B is switched off (OFF) and when it is switched on (ON).

The individual submenus are presented, described and explained in detail in chapters 6.3.3 to 6.3.9.

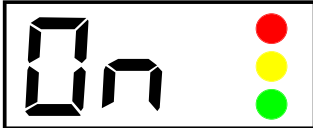
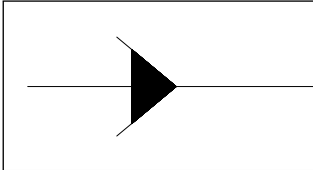
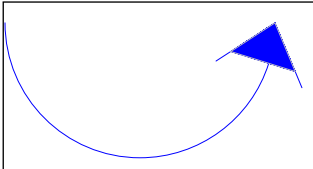
The symbolic representations used below are described as follows:

Symbol	Description	Note	Chapter
	LCD display	The LCD displays information both during operation and for programming purposes.	6.3.1
	Sequence arrow	The black sequence arrow indicates the unchangeable basic structure of the menu.	./.
	Action arrow	The blue action arrow shows the consequence of touching the action area with the activation and programming key.	6.3.2
	Submenu	In the respective submenu's information can be read, dispensing processes can be initiated and settings can be changed.	6.3.4 to 6.3.9

- ① The PRO menu is only accessible from ON mode (LUB-S-B is switched on). The PRO menu allows you to make changes to the LUB-S-B settings - and thus to its dispensing behavior. For details see chapter 6.3.8 and 6.3.9.
- ① The FIL menu is only accessible from ON mode (LUB-S-B is switched on). The FIL menu allows you to manually trigger a fixed number of dispenses at LUB-S-B. For details see chapter 6.3.10.

7.3.1 LCD

The LCD displays information about various states of LUB-S-B.

Depending on the state of the LUB-S-B you will be supported by three coloured LEDs to the right of the LCD. This allows you to assess the condition of LUB-S-B from a distance. Basic meanings: green=OK; red=error. The following tables show the LED assignment on the LCD as well as the explanation of the respective output.

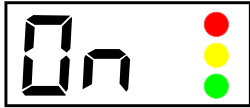
LCD	Assignment
	upper LED: red middle LED: yellow lower LED: green

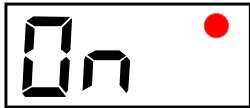
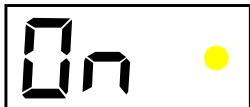
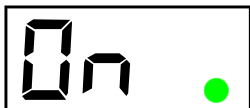
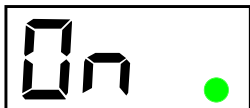
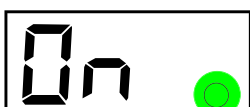
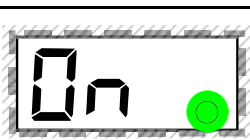
LCD	Description	Naming	Chapter
	The red LED only lights up if there is an error.	Error on LUB-S-B	6.4
	The yellow LED only lights up if the activation and programming key has touched the action surface (activation and programming key detected).	Activation and programming key detected by LUB-S-B	6.3
	The green LED lights up during a dispensing process for approx. 10...18 seconds.	LUB-S-B dispenses lubricant	6.3
	The green LED lights up when changes are possible and the activation and programming key was previously detected.	Changes possible	6.3
	The green LED flashes every 5 seconds when LUB-S-B is ON and no error occurs.	LUB-S-B is ready for use	6.3
	The green LED flashes twice when a value has been confirmed. Additionally the LCD also flashes twice.	Acceptance of changed value	6.3

Display in LCD	Meaning	Chapter	
<i>no display</i>	Battery not connected; battery completely discharged	6.3.3	
OFF	LUB-S-B is switched off	6.3.3	
On	LUB-S-B is ready for operation; LUB-S-B dispenses lubricant in accordance to the operating mode and the values set	6.3.3	
Errors			
E1	Error E1 (empty cartridge / cartridge error)	6.4	
E2	Error E2 (overload / overpressure)	6.4	
E3	Error E3 (undervoltage, battery empty)	6.4	
E4	Error E4 (fatal error)	6.4	
Submenus			
INF	INF menu		6.3.4 6.3.5
	b01	Firmware version of LUB-S-B	
	h06	Currently set value of dispensing time h	
	c01	Currently set value of number of strokes c	
	6	Currently set value of emptying time Et	
SET	SET menu		6.3.6
	-h-	Operating mode: hour mode	
	Et	Operating mode: empty time mode	
RUN	RUN menu		6.3.7
	01...35	During the manually triggered active RUN command ("Quick-Check"/extra dispense), the LCD displays the approximate back pressure in bar. In addition, the green LED lights up.	
PRO	PRO menu		6.3.8 6.3.9
	h1...99	Adjustable setting of dispensing time h	
	c1...10	Adjustable setting of number of strokes c	
	1...24	Adjustable setting of emptying time Et	

FIL	FIL menu		6.3.10
	01...35	During the manually triggered active FIL command, the LCD displays the approximate back pressure in bar. In addition, the green LED lights up.	
	Clr	If the process is aborted during the FIL command Clr appears at first.	

Additional characters on the LCD

	Displayed when the cartridge is empty and the cartridge and battery need to be replaced.	7.2
MAX	After each cycle the maximum back pressure is displayed in bar.	

7.3.2 Actions with the activation and programming key

The activation and programming key attached to the bottom of LUB-S-B allows you to perform actions and changes in the settings of LUB-S-B. This activation and programming key can be easily and permanently stored underneath LUB-S-B.

1

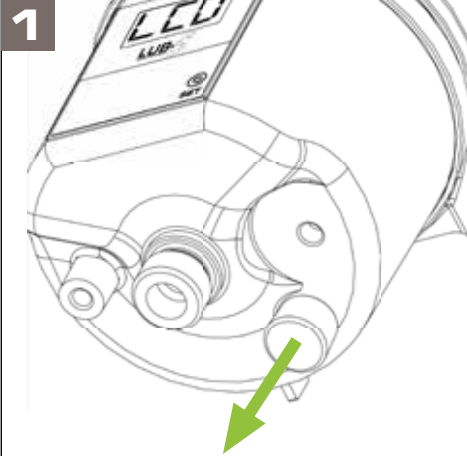

Remove the key

- ✦ Remove the activation and programming key from the underside of LUB-S-B.
- ⓘ The activation and programming key is permanently held magnetically in the hole on the underside. Simply pull it out.

2



Guide the activation and programming key to the action area (SET)

- ✦ Place the activation and programming key on the action area on the front of LUB-S-B.
- ➔ As soon as the activation and programming key on the action area (SET) has been detected by LUB-S-B, the yellow LED lights up. The menu blends in in a rhythm of approx. 2 seconds.
- ✦ Remove the activation and programming key from the action area (SET) as long as the desired menu item is displayed in the LCD.
- ➔ The yellow LED disappears. You have performed an action. The LCD and the green LED flash twice.

✦ At the end of the action or setting reinsert the activation and programming key into the hole provided on the underside of LUB-S-B.

ⓘ The hole on the bottom of LUB-S-B does not necessarily have to be used to store the activation and programming key. If you want to protect LUB-S-B against unintentional modification or manipulation, you can also store the activation and programming key in another location. Please note, however, that if faults or changes shall be made, no changes or actions can be carried out on LUB-S-B without the activation and programming key.

7.3.3 Switching on and off

Switching on LUB-S-B:

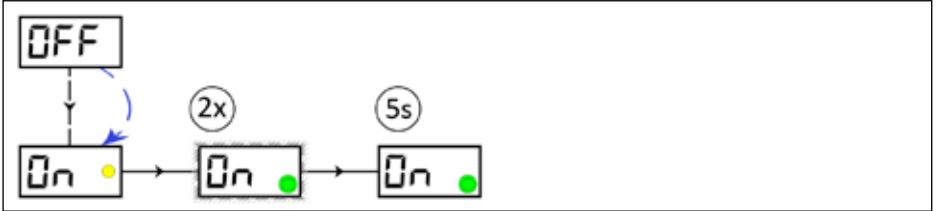

✓ LUB-S-B is switched off (OFF).

✦ Hold the activation and programming key onto the action surface. The yellow LED lights up. Leave the activation and programming key on the action area until ON is displayed in the LCD. Remove the activation and programming key from the action area as long as ON is displayed. The yellow LED disappears; the LCD and the green LED flash twice.

⇒ If no error is detected during the LUB-S-B self-check, ON is displayed in the LCD. The green LED lights up once every 30 seconds, LUB-S-B is ready for operation and will dispense lubricant according to the set values.

✦ Insert the activation and programming key into the hole provided on the underside of LUB-S-B.

Switching off LUB-S-B:



✓ LUB-S-B is switched on (ON), the green LED flashes every 30 seconds.

✦ Hold the activation and programming key onto the action surface. The yellow LED lights up. Leave the activation and programming key on the action area until OFF is displayed in the LCD. Remove the activation and programming key from the action area as long as OFF is displayed. The yellow LED disappears; the LCD and the green LED flash twice.

⇒ LUB-S-B is OFF; OFF appears in the LCD. LUB-S-B stops dispensing lubricant.

✦ Insert the activation and programming key into the hole provided on the underside of LUB-S-B.

ⓘ LUB-S-B can be switched off in any state (normal operating state or error) in the manner described above.

7.3.4 INF menu, operating mode: hour mode -h-

The INF menu informs the user about the firmware used in LUB-S-B and the settings made earlier and are currently active (values of the adjustable variables t and c that can be changed in the PRO menu).

In the INF menu nothing can be changed by the user. The values of the parameters are displayed in a fixed order.

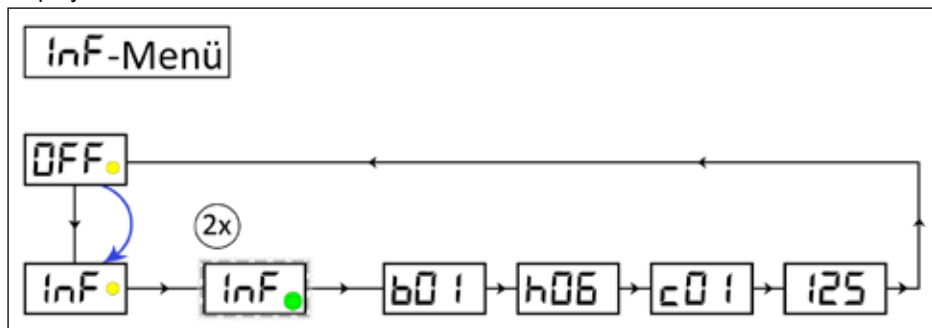

n alphanumeric name of the LUB-S-B firmware

h set value of variable *h* dispensing time

c set value of variable *c* number of cycles

125 set value of the size of the lubricant cartridge

✦ Remove the activation and programming key from the bottom of LUB-S-B and place it onto the action area.

✦ Hold the activation and programming key onto the action surface. The yellow LED lights up. Leave the activation and programming key on the action area until INF is displayed in the LCD. Remove the activation and programming key from the action area as long as INF is displayed. The yellow LED disappears; the LCD and the green LED flash twice.

⇒ The LCD informs you on the set values.

✦ Insert the activation and programming key into the hole provided on the underside of LUB-S-B.

ⓘ The INF menu can only be accessed from OFF mode (LUB-S-B is switched off). When you have entered the INF menu, you will return to OFF mode.

7.3.5 INF menu, operating mode: empty time mode Et

The INF menu is used to inform the user about the firmware used in LUB-S-B and the settings made earlier and are currently active (value of the adjustable variable Et that can be changed in the PRO menu).

In the INF menu nothing can be changed by the user. The values of the parameters are displayed in a fixed order.

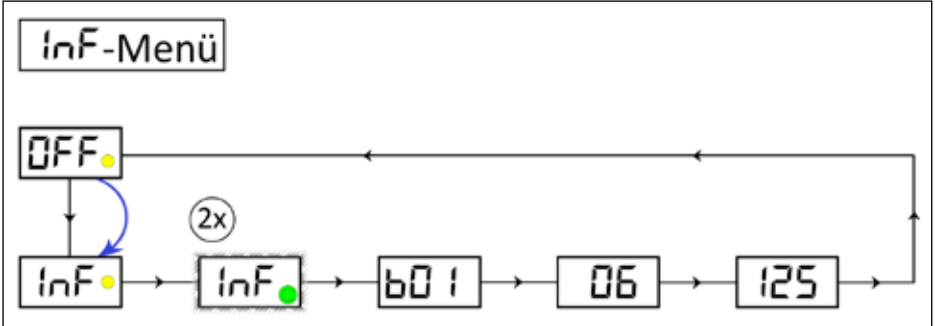

- n* alphanumerical name of the LUB-S-B firmware
- Et* set value of the variable Et emptying time in months
- 125 set value of the size of the lubricant cartridge

✦ Remove the activation and programming key from the bottom of LUB-S-B and place it onto the action area.

✦ Hold the activation and programming key on the action surface. The yellow LED lights up. Leave the activation and programming key on the action area until INF is displayed in the LCD. Remove the activation and programming key from the action area as long as INF is displayed. The yellow LED disappears; the LCD and the green LED flash twice.

⌚ The LCD informs you on the set values.

✦ Insert the activation and programming key into the hole provided on the underside of LUB-S-B.

ⓘ The INF menu can only be accessed from OFF mode (LUB-S-B is switched off). When you have entered the INF menu, you will return to OFF mode.

7.3.6 SET menu

The SET menu allows you to change the operating mode of LUB-S-B. You can switch between **hour mode -h-** and **empty time mode Et**. The hour mode -h- allows you to set the number of cycles (c) within a dispensing time (h) in hours. The empty time mode Et allows you to set the emptying time (Et) of the cartridge in months. Cycles (c) and dispensing time (h) or emptying time (Et) can be adjusted after selecting the operating mode in the PRO menu, see chapter 6.3.8.

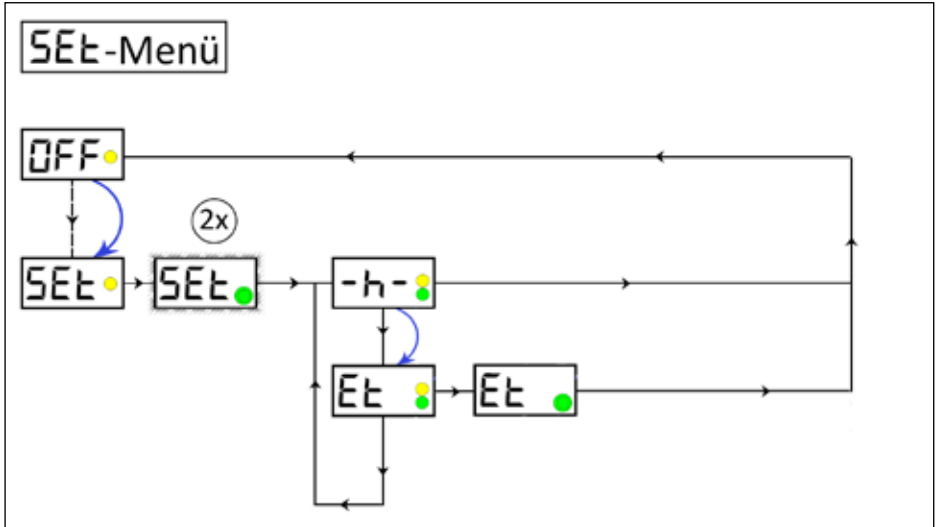

-h- Operating mode: hour mode -h-
Et Operating mode: empty time mode Et

- ✓ LUB-S-B is switched off (OFF)
- ✦ Remove the activation and programming key from the bottom of LUB-S-B and place it onto the action area.
- ✦ Hold the activation and programming key onto the action surface. The yellow LED lights up. Leave the activation and programming key on the action area until SET is displayed in the LCD.
- ✦ Remove the activation and programming key from the action area.
- ⊙ The yellow LED disappears; the LCD and the green LED flash twice. The LCD displays the operating mode currently set. Now you are able to change the operating mode.

Changing the operating mode:

- ✦ If you would like to change the operating mode, move the activation and programming key back to the action area.
- ➡ The yellow LED lights up and the LCD displays the currently unselected operating mode. The yellow LED lights up as long as the activation and programming key is on the action surface; the two adjustable operating modes run alternately.
- ✦ When your desired operating mode is displayed on the LCD, remove the activation and programming key from the action area.
- ➡ The yellow LED disappears; the LCD and the green LED flash twice. The selected operating mode has now been accepted.

Not changing the operating mode:

- ✦ If you do not want to change operating mode, the activation and programming key must remain removed from the action area.
 - ➡ The LCD and the green LED flash twice whereby the operating mode is displayed in the LCD.
- ⓘ The SET menu can only be accessed from OFF mode (LUB-S-B is switched off). When you have entered the SET menu, you will return to OFF mode.

7.3.7 RUN menu

The RUN menu is used to manually activate LUB-S-B and enables triggering an extra dispense. This function can be used, for example, to manually check the condition of the lubrication point ("quick check").

LUB-S-B carries out an extra dispense after triggering the RUN function. During the stroke, the back pressure detected by the integrated microelectronics is displayed in the LCD as an approximate value in bar.

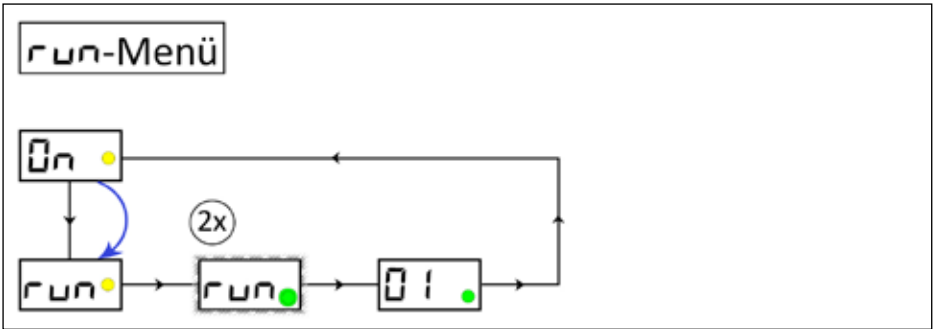

✓ There is no fault or error at LUB-S-B.

✦ Remove the activation and programming key from the bottom of LUB-S-B and place it onto the action area.

✦ Hold the activation and programming key onto the action surface. The yellow LED lights up. Leave the activation and programming key on the action area until RUN is displayed in the LCD. Remove the activation and programming key from the action area as long as RUN is displayed. The yellow LED disappears.

➡ The LCD and the green LED flash twice. LUB-S-B starts to pump the lubricant to the outlet (extra dispense or "Quick-Check").

✦ Insert the activation and programming key into the hole provided on the underside of LUB-S-B or repeat the extra dispense ("Quick-Check") if necessary.

✦ Observe the back pressure values displayed on the LCD if they are of interest.

ⓘ During the dispensing process the green LED lights up; in addition, the stroke's counterpressure is displayed in the LCD.

ⓘ The RUN menu can only be reached from ON mode (LUB-S-B switched on). When you have entered the RUN menu, you will return to ON mode.

7.3.8 PRO menu, operating mode: hour mode -h-

The PRO menu allows you to change the settings of LUB-S-B's dispensing behavior. Being in operating mode hour mode -h-, you can change the dispensing time h as well as the number of cycles c (number of strokes). During the dispensing time h LUB-S-B executes exactly the number of strokes c (each 0.16 cm^3) specified in the number of cycles c . The cycles c are evenly distributed over the dispensing time h .

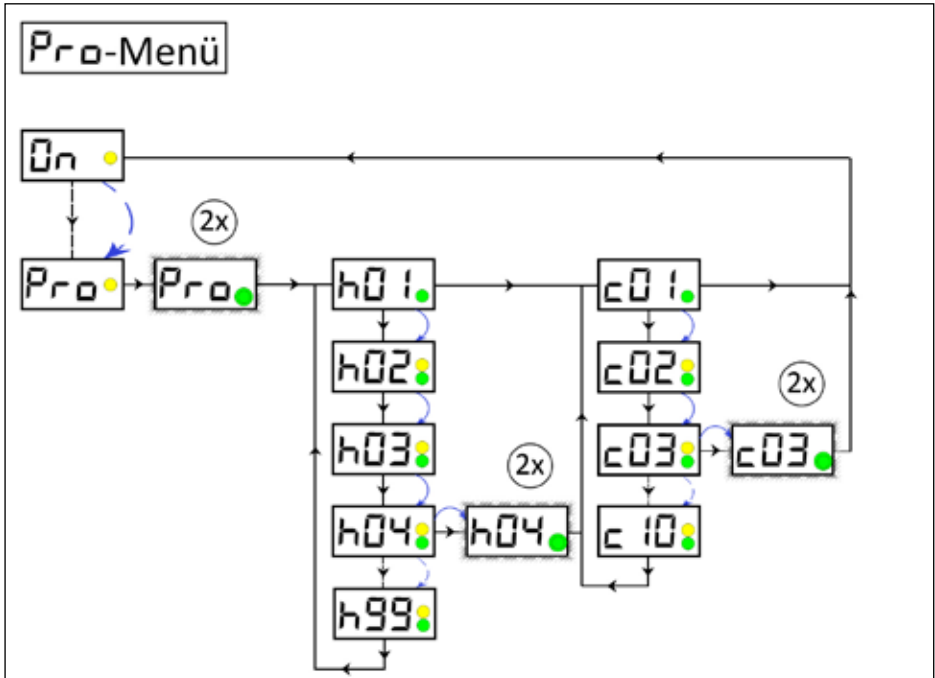

✓ There is no fault or error at LUB-S-B.

Being in PRO menu the first step is to set the dispensing time h and afterwards the number of cycles c ; direct access to the number of cycles c is not possible.

✦ Remove the activation and programming key from the bottom of LUB-S-B and place it onto the action area. Hold the activation and programming key onto the action surface. Leave the activation and programming key on the action area until PRO is displayed in the LCD.

✦ Remove the activation and programming key from the action area as long as PRO is displayed.

⇒ The LCD and the green LED flash twice. The LCD first displays the value of dispensing time h (h_{is}) currently set. Now you are able to change the values of dispensing time h .

Changing the value of dispensing time h:

✦ If you would like to change the value of dispensing time h move the activation and programming key back to the action area.

➡ In the LCD the next higher ($h_{is} + 1$) adjustable value of dispensing time h is displayed. The green LED lights up as long as the activation and programming key is placed on the action surface; the other values of dispensing time h run through one after the other. However, you can also remove the activation and programming key from the action area and bring it back there shortly afterwards to reach each value one after the other. If the final value of the dispensing time h of $h=99$ is reached and no value has been selected the menu returns to $h=01$ and the cycle can be restarted.

✦ As long as the new chosen value for dispensing time h (h_{new}) is displayed in the LCD remove the activation and programming key from the action area.

➡ The yellow LED disappears, the green LED and the LCD flash twice. The selected new value ($h_{new} = h_{is}$) of dispensing time h has now been accepted. The submenu will now automatically take you to the values of the number of cycles c.

No changing of the value of dispensing time h:

✦ If you do not want to change the value of dispensing time h the activation and programming key must remain removed from the action area immediately after entering the PRO menu.

➡ The LCD as well as the green LED flash twice and the dispensing time h is displayed in the LCD. The submenu now automatically takes you to the values of the number of cycles.

The LCD now displays the currently set value of the number of cycles c (c_{is}). Now you have the possibility to change the values of the number of cycles c.

Changing the value of the number of cycles c:

✦ If you want to change the value of the number of cycles c move the activation and programming key back to the action area.

➡ In the LCD the next higher ($c_{is} + 1$) adjustable value of the number of cycles c is displayed. The green LED lights up as long as the activation and programming key is placed on the action surface; the other values of the number of cycles c run through one after the other. However, you can also remove the activation and programming key from the action area and bring it back there shortly afterwards to reach each value one after the other. If the final value of the number of cycles c of $c=10$ is reached and no value has been selected, the menu returns to $c=01$ and the cycle can be restarted.

✦ As long as the new chosen value for the number of cycles c (c_{new}) is displayed in the LCD remove the activation and programming key from the action area.

➡ The yellow LED disappears, the green LED and the LCD flash twice. The selected new value ($c_{new} = c_{is}$) of dispensing time h has now been accepted.

No changing of the value of the number of cycles c:

✦ If you do not want to change the value of the number of cycles c the activation and programming key must remain removed from the action area immediately after entering the PRO menu.

➡ The LCD and the green LED flash twice and the number of cycles c is displayed in the LCD.

✦ Insert the activation and programming key into the hole provided on the underside of LUB-S-B.

ⓘ The PRO menu can only be reached from ON mode (LUB-S-B switched on). When leaving the PRO menu you will return to ON mode.

ⓘ If you have made changes to the values of dispensing time h or number of cycles c in the PRO menu and LUB-S-B is otherwise ready for operation (battery full and inserted as well as a cartridge fitted), LUB-S-B will immediately start the calculated waiting time until the next dispenses.

✦ Observe the back pressure values displayed on the LCD if they are of interest.

ⓘ During the dispensing process the green LED lights up; in addition, the stroke's counterpressure is displayed in the LCD.

The parameters that can be set for dispensing time h and the number of cycles c and their respective permissible values are specified as follows:

h= **Dispensing time** in hours (h).

The dispensing time can be set between 1 | 2 | 3 | ... | 99 hours.

The time counter integrated in the microelectronics of LUB-S-B starts counting the dispensing time h at the end of a successful and fully completed dispensing cycle.

c= **Number of cycles** within a dispensing cycle (c).

The number of cycles c can be set between 1 | 2 | 3 | ... | 10 strokes.

7.3.9 PRO menu, operating mode: empty time mode Et

The PRO menu allows you to change the settings of the LUB-S-B's dispensing behavior. Being in empty time mode Et, you can change the emptying time Et in months. The LUB-S-B automatically calculates the pause time between two cycles to reach the set emptying time in months.

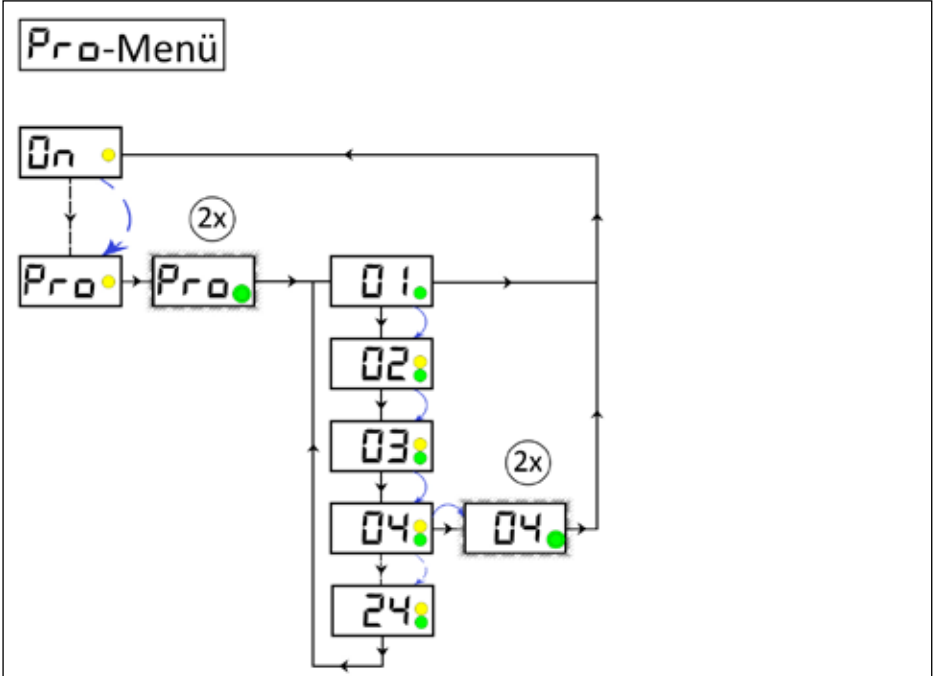

✓ There is no fault or error at LUB-S-B.

✦ Remove the activation and programming key from the bottom of LUB-S-B and place it onto the action area. Hold the activation and programming key onto the action surface. Leave the activation and programming key on the action area until PRO is displayed in the LCD.

✦ Remove the activation and programming key from the action area as long as PRO is displayed.

➡ The LCD and the green LED flash twice. The LCD first displays the value of the emptying time Et (Et_{is}) currently set. You are now able to change the values of emptying time Et.

Changing the value of emptying time Et:

✦ If you would like to change the value of emptying time Et move the activation and programming key back to the action area.

➡ In the LCD the next higher ($Et_{is} + 1$) adjustable value of emptying time Et is displayed. The green LED lights up as long as the activation and programming key is placed onto the action surface; the other values of emptying time Et run through one after the other. However, you can also remove the activation and programming key from the action area and bring it back there shortly afterwards to reach each value one after the other. If the final value of emptying time Et of $Et=24$ is reached and no value has been selected, the menu returns to $Et=01$ and the cycle can be restarted.

✦ As long as the new chosen value for the emptying time Et (Et_{new}) is displayed in the LCD, remove the activation and programming key from the action area.

➡ The yellow LED disappears, the green LED and the LCD flash twice. The selected new value ($Et_{new} = Et_{is}$) of dispensing time h has now been accepted.

No changing of the value of emptying time Et:

✦ If you do not want to change the value of emptying time Et the activation and programming key must remain removed from the action area immediately after entering the PRO menu.

➡ The LCD and the green LED flash twice and emptying time Et is displayed in the LCD.

✦ Insert the activation and programming key into the hole provided on the underside of LUB-S-B.

ⓘ The PRO menu can only be reached from ON mode (LUB-S-B switched on). When entering the PRO menu, you will return to ON mode.

ⓘ If you have made changes to the values of emptying time Et in PRO menu and LUB-S-B is otherwise ready for operation (battery full and inserted as well as a cartridge fitted), LUB-S-B will immediately start the calculated waiting time until the next dispenses.

✦ Observe the back pressure values displayed on the LCD if they are of interest.

ⓘ During the dispensing process the green LED lights up; in addition, the stroke's counterpressure is displayed in the LCD.

The parameters that can be set for emptying time Et and their respective permissible values are specified as follows:

Et= **Emptying time** of a full cartridge in months (Et).

The emptying time can be set between 1 | 2 | 3 | ... | 24 months.

The time counter integrated in the microelectronics of LUB-S-B starts counting the pause time at the end of a successful and fully completed dispensing cycle.

7.3.10 FIL menu

The FIL menu allows you to trigger a defined multiple dispense of LUB-S-B. The activation initiates a total of 40 pump strokes. This function enables you to prefill connected accessories (tubes, distributors,...) with the lubricant contained in the lubricant cartridge, especially during the initial start-up of LUB-S-B. However, the process can also be aborted manually at any time.

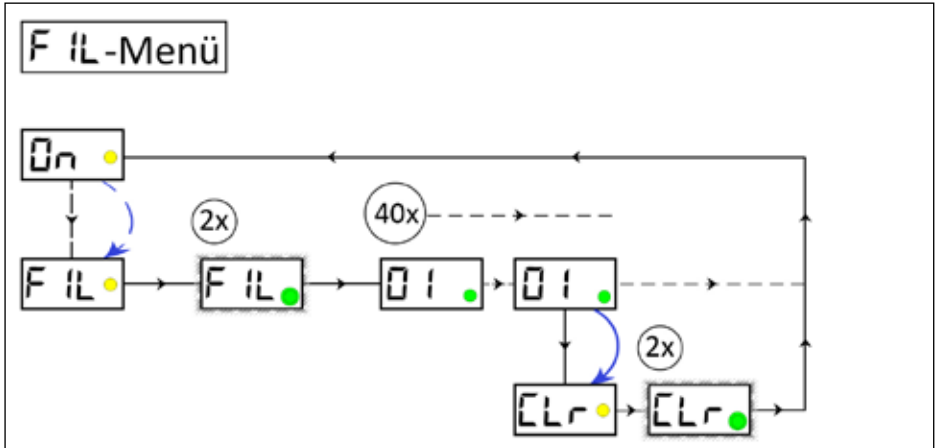

✓ There is no fault or error at LUB-S-B.

✦ Remove the activation and programming key from the bottom of LUB-S-B and place it on the action area. The yellow LED will light up. Leave the activation and programming key on the action area until FIL is displayed in the LCD. Remove the activation and programming key from the action area. The yellow LED disappears.

⇒ The LCD and the green LED flash twice. LUB-S-B starts dispensing. The green LED lights up during each dispense.

✦ If you do not want to cancel the process: Insert the activation and programming key into the hole provided on the underside of LUB-S-B.

⇒ LUB-S-B dispenses 40 strokes of lubricant.

✦ If you would like to cancel the process: Place the activation and programming key on the action area and wait until the end of a dispensing process (motor run).

⇒ CLR appears in the LCD.

✦ Remove the activation and programming key from the action area.



⇒ LUB-S-B stops the FIL command.

✦ Observe the back pressure values displayed on the LCD if they are of interest.

- ① During the dispensing process the green LED lights up; in addition, the stroke's counterpressure is displayed in the LCD.
- ① The FIL menu can only be reached from ON mode (LUB-S-B switched on). When you enter the FIL menu, you will return to ON mode even if you cancel FIL prematurely with CLR.

7.4 Error codes

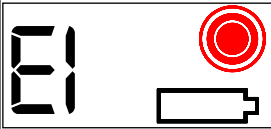
The microelectronics integrated in LUB-S-B permanently monitor the status. In case of irregularities an addressed error message is displayed on the LCD. The red LED flashes every 5 seconds and signals an error.

LCD	Name	Description	Remedy
	Error E1	Cartridge error; Cartridge not recognized or not mounted correctly	<ul style="list-style-type: none"> ✦ Place a new cartridge on LUB-S-B (see chapter 7.2). ① No confirmation of error necessary; it is automatically cleared after the remedial action.
	Error E1	Cartridge (symbol) empty	<ul style="list-style-type: none"> ✦ Place a new cartridge on LUB-S-B (see chapter 7.2). ① No confirmation of the error necessary; it is automatically cleared after the remedial action.
	Error E2	Overload, the backpressure at the lubrication point is too high	<ul style="list-style-type: none"> ✦ Check the lubrication point and eliminate the fault's cause. ✦ Switch LUB-S-B off (OFF) and on (ON) again.
	Error E3	Battery empty	<ul style="list-style-type: none"> ✦ Switch LUB-S-B off (OFF). ✦ Replace the battery together with the cartridge (see chapter 7.2). ✦ Switch LUB-S-B on (ON).

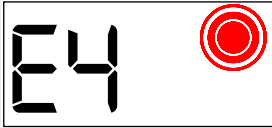
LCD	Name	Description	Remedy
	Error E4	Fatal error	<p>✦ Disassemble LUB-S-B and return it to the manufacturer together with the lubricant cartridge and a description of faults.</p> <p>ⓘ A fatal error usually concerns the electronics of LUB-S-B and cannot be repaired by you on site.</p> <p>ⓘ The manufacturer's address can be found in chapter I.II.</p>

9. Maintenance and disposal

✦ Before starting any maintenance work, inform yourself about the general safety instructions (see chapter 2) and observe the relevant local and operational safety regulations.

✦ Do not deactivate any protective device without authorization!

7.5 Maintenance schedule

The following maintenance schedule must be observed for LUB-S-B:

Maintenance	Commissioning	After 500 hours or after 3 months	Annually	If required
Cleaning	x	x	x	x*
Visual check	x	x	x	x*
Battery change	x**		x***	x*
Cartridge change	x**		x***	x*

* Depending on operating conditions and lubricant consumption

** Depending on delivery status (ordered version)

*** after 2 years at the latest

7.5.1 Visual check

- ✦ Check the entire lubrication system (LUB-S-B and any connected accessories including tubes and distributors) for external damage (e.g. loose or loosened tubes) by a thorough and conscientious visual inspection.
- ✦ Check the condition of the lubrication point for correct supply of lubricant.
- ✦ Replace damaged or defective parts immediately to ensure permanent lubrication.
- ✦ Check the filling level of the cartridge on LUB-S-B.
- ✦ Check possible error messages on LUB-S-B and remedy the causes accordingly.

7.5.2 Cleaning





- ✦ Clean LUB-S-B from dirt using suitable cleaning agents (e.g. absorbent towels, cloths).

	NOTICE
	<p>Compressed air can damage the seals of LUB-S-B as well as transport dirt and foreign bodies into LUB-S-B or the lubricant.</p> <ul style="list-style-type: none">• Do not use compressed air to clean LUB-S-B.

7.5.3 Recommissioning after maintenance

- ✦ Reinstall all safety devices and make sure that no tools remain in the danger area.
- ✦ Check if LUB-S-B is switched on.
- ✦ Carry out a "Quick Check" (test run) using the RUN command (section 6.3.7).

7.6 Cartridge and battery change

	<p style="text-align: center;">NOTICE</p> <p>A used lubricant cartridge must not be replaced on LUB-S-B as the integrated stroke counter of LUB-S-B is automatically reset by the cartridge sensor after a cartridge has been removed.</p> <ul style="list-style-type: none"> • Only use full lubricant cartridges.
	<p style="text-align: center;">NOTICE</p> <p>Only use original lubricant cartridges with lubricant approved by the manufacturer.</p> <ul style="list-style-type: none"> • Observe the maximum shelf life of lubricant filled in cartridges.
	<p style="text-align: center;">NOTICE</p> <p>It is not possible to refill empty or opened lubricant cartridges.</p>
	<p style="text-align: center;">NOTICE</p> <p>Make sure you use the same lubricant in the new cartridge that is already in use.</p> <ul style="list-style-type: none"> • Compare the data on the lubricant cartridge.
	<p>The battery of LUB-S-B must be replaced at the same time as the lubricant cartridge!</p> <ul style="list-style-type: none"> • Observe the safety instructions for the battery.

Changing the lubricant cartridge of LUB-S-B is very easy.

In the present version of a battery-powered LUB-S-B the battery has to be changed at the same time as the cartridge. The cartridge needs to be changed if it is empty itself, if the battery is empty or the service life of the lubricant has been exceeded. The cartridge and battery can be changed during normal operation of LUB-S-B.

✓LUB-S-B has a fault (error E1 or error E2); the red LED flashes every 5 seconds.

OR

✓The LUB-S-B battery is completely discharged, the LCD is dark (OFF is not displayed).

1



Unscrew empty cartridge

✦ Turn the empty cartridge counterclockwise from LUB-S-B and dispose it properly afterwards.

ⓘ Pay attention to cleanliness during work. Make sure that dirt and foreign bodies do not get into the lubricant inlet. If necessary, carry out cleaning work beforehand (chapter 7.1.2).

2

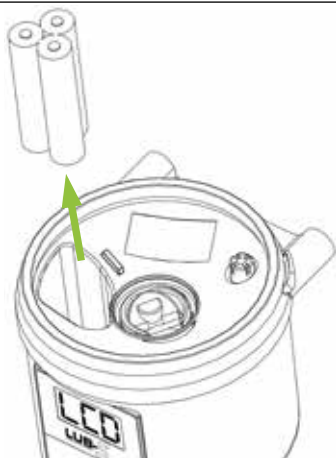

Remove empty battery

✦ Use the battery cable to pull the empty battery out of the battery compartment.

✦ Disconnect the reverse polarity protected plug connection and dispose of the empty battery properly afterwards.

3



Insert new battery

- ✦ Connect the new battery to the battery cable using the reverse polarity protected plug.
 - ✦ Store the battery and the battery cable in the battery compartment.
- ⓘ Make sure that the battery cable or plug does not protrude from the battery compartment.

4



Mount new lubricant cartridge

- ✦ Place the full lubricant cartridge onto LUB-S-B.
- ✦ Turn the lubricant cartridge clockwise onto LUB-S-B.

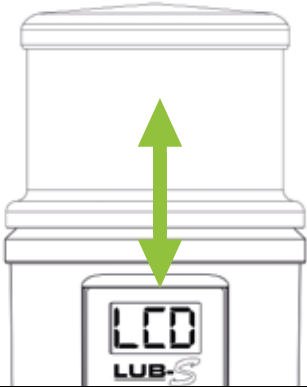

- ⓘ The end position is reached after 2 full rotations when the label of the lubricant cartridge is aligned with the front foil of LUB-S-B.

✦ Carry out the work as described above.

- ➔ If an error was displayed in the LCD before changing the cartridge or battery, the message will now disappear, as will the flashing red LED. A separate confirmation is not necessary. The green LED flashes briefly every 30 seconds.
- ➔ LUB-S-B automatically returns to the last active mode (ON or OFF).

ⓘ If the empty state of the cartridge (error E1) was reached during a dispensing cycle, it is interrupted and continued automatically after completing the work explained above.

7.7 Disposal

- ✦ When disposing LUB-S-B, empty or opened cartridges and batteries, follow the relevant national regulations in force.
 - ✦ When disposing LUB-S-B observe the relevant safety data sheets and disposal instructions for the individual components.
- ⓘ Batteries cannot be recharged.
 - ⓘ It is not possible to refill empty lubricant cartridges.

8. Released accessories

The present LUB-S-B can be considerably extended by the extensive system and accessory program from use as a single point lubricator. This may necessitate changes to the factory and/or the default settings of LUB-S-B to ensure reliable and proper operation of LUB-S-B combined with the hydraulically connected accessories.

Amongst others, cartridges filled with different lubricants, brackets and thread adapters are available.

For more information please contact the manufacturer or visit its website www.G-LUBE.com.

8.1 Lubricants

Only use lubricants approved by the manufacturer Gruetzner GmbH in the original cartridges developed and manufactured exclusively for LUB-S-B.

	NOTICE
	The lubricant used in each case differs according to the application. The respective designation can be found on the label of the cartridge.

Further information on lubricants, documentation and safety data sheets can be obtained directly from the manufacturer Gruetzner GmbH.

8.2 Tube lengths

Generally it is recommended to install LUB-S-B as close as possible to the consumer (lubrication point). Ideally, this should be done directly at or on the lubrication point. In cases where this is not possible due to the installation space or for reasons of reachability or accessibility, tubes can also be used between LUB-S-B and the lubrication point (or distributor).

The tube length shall not exceed 4 meters, the inner tube diameter shall not be lower than 4 mm. The maximum tube length depends on a wide range of parameters such as temperature, application and viscosity of the lubricant used.

9. Appendix 9.1 Dimension sheet and installation dimensions

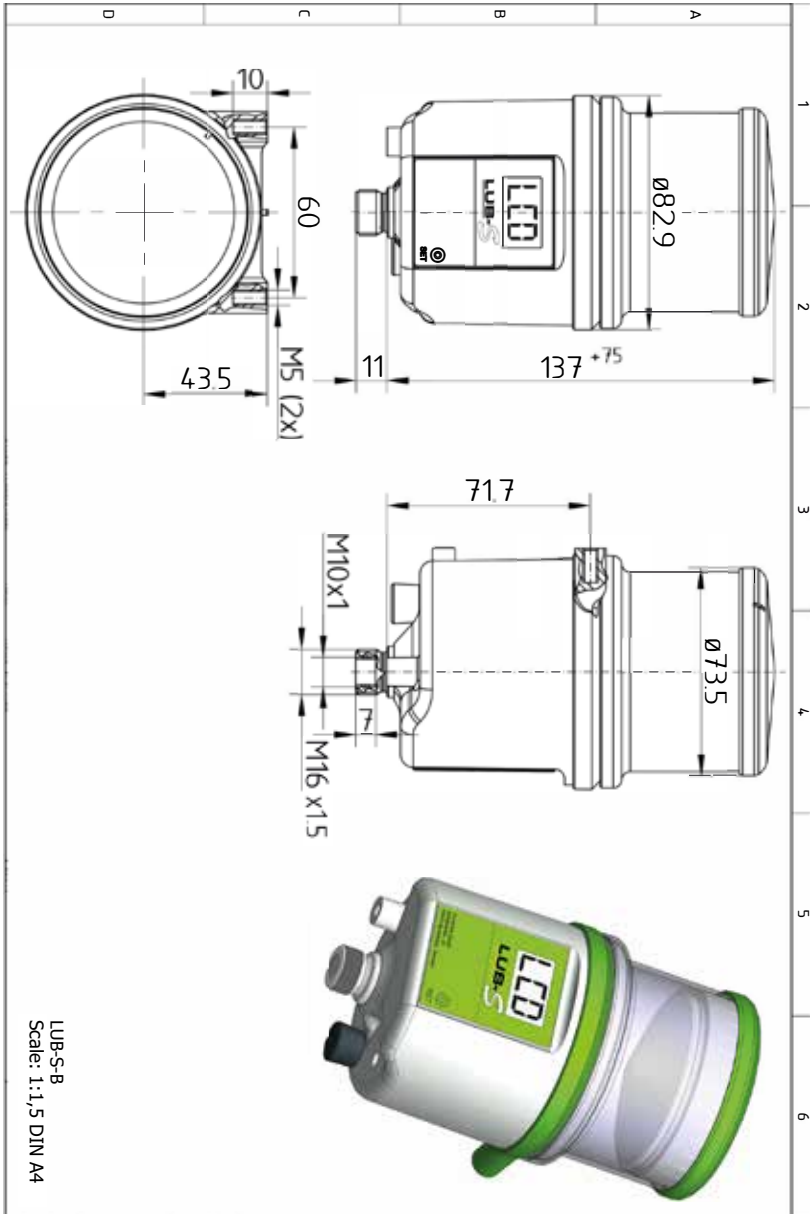

9.2 EC/EU Declaration of conformity

EC declaration of conformity



**Declaration of conformity
according to EC machinery directive 2006/42/EC as of 17. May 2006**



The manufacturer or authorised representative*

Gruetzner GmbH, Kohlenhofstr. 60, 90443 Nuremberg, Germany

hereby declares that the following lubrication systems

Product designation: LUB-S

Type designation: LUB-S-V (24 VDC power supply), **LUB-S-B** (battery powered)

comply with the essential requires of EC directive 2006/42/EC.

The following harmonized standards have been applied:

EN 12100:2011 Safety of machines

Additionally the systems comply with the regulations for electromagnetic compability according to 2004/108/EC.

The following harmonized standards have been applied:

EN 61000-6-2, EN 61000-6-4 electromagnetic compability

Authorised representative for the compilation of technical documents:

Volker Grützner, CEO, Gruetzner GmbH, Kohlenhofstr. 60, 90443 Nuremberg, Germany

Nuremberg, 01.10.2019



Volker Grützner, CEO

*must be based within the EU

Gruetzner GmbH

Kohlenhofstr. 60

90443 Nuremberg, Germany

Tel: +49 911 277399-0

Fax: +49 911 277399-99

info@G-LUBE.com

www.G-LUBE.com



GRUETZNER
AUTOMATIC LUBRICATION



9.3 Spare parts

Art. no.	Designation	Application
LAT-BAT-SA	Battery pack LUB-S-B, Alkaline	Operation of LUB-S-B
LAT-BAT-SL	Battery pack LUB-S-B, Lithium	Operation of LUB-S-B



GRUETZNER
AUTOMATIC LUBRICATION



G | LUBE



SOLOLUBE

AUTOMATIC LUBRICATION



LUB 5



LUBRICUS

Gruetzner GmbH

Dagobertstr. 15 • D - 90431 Nuremberg, Germany

Tel. +49 911 277 399 0 • info@G-LUBE.com • www.G-LUBE.com