

Progressive distributors

User manual



GRUETZNER
AUTOMATIC LUBRICATION

Progressive distributors

I. Revision history & imprint

I.I Revision history

The present user manual is the original user manual.

This user manual is only valid for

Product:

Product designation: Gruetzner
progressive distributors
(PRV)

Product revision: ---

User manual:

Date of creation: 07.2020

Revision of the user manual: 0

This document is protected by copyright.

All rights for layout, content, texts and corporate design are reserved by Gruetzner GmbH, © 2020.

All rights, including those of photomechanical reproduction, duplication and distribution by means of special processes (e.g. data processing, data carriers and data networks), even in part and/or in extracts, are reserved by Gruetzner GmbH.

The content and technical specifications are subject to change without notice.

I.II Imprint

Address:

Gruetzner GmbH
Dagobertstr. 15
90431 Nuremberg, Germany
Tel: +49 (0)911 277 399-0
Fax: +49 (0)911 277 399-99
info@G-LUBE.com
www.G-LUBE.com

Commercial Register of Nuremberg Local Court:
HRB 12109

USt-ID: DE 160441123

CEO: Volker Grütznert

I.III Table of contents

Chapter	Content	Page
I.	Revision history & Imprint	02
I.I	Revision history	02
I.II	Imprint	02
I.III	Table of contents	03
1.	General information about this manual	05
1.1	Signal words	05
1.2	Warning symbols	06
1.3	Structure of the safety instructions	06
1.4	Symbols for information	06
2.	Safety	07
2.1	Hazards	07
2.2	Staff	07
2.3	Reasonably predictable misuse	07
2.4	Usage for the intended purpose	08
2.5	Warranty and liability	08
2.6	General safety instructions	09
3.	Description of function	10
3.1	General information	10
3.2	Identification	11
3.3	Scope of delivery	11
3.4	Technical data	12
3.5	Special distributors	14
4.	Transport and storage	15
4.1	Packaging	15
4.2	Transport	15
4.3	Storage	15

Progressive distributors

Chapter	Content	Page
5.	Mounting / Commissioning / Operating	16
5.1	Preparations	16
5.2	Mounting	16
5.3	Commissioning	19
5.4	Operating	19
5.5	Troubleshooting	20
6.	Maintenance and disposal	21
6.1	Maintenance schedule	21
6.1.1	Visual check	21
6.1.2	Cleaning	21
6.1.3	Recommissioning after maintenance	21
6.2	Disposal	22
7.	Released accessories	23
7.1	Lubricants	23
7.2	Tube lengths	23
8.	Appendix	24
8.1	Dimension sheet and installation dimensions	24
8.2	Drilling pattern for PRV	25

1. General information about this manual

This user manual contains all necessary information to use Gruetzner monitored distributors, hereinafter referred to as PRV, safely and as intended. In the event that supplementary sheets are attached to these instructions, the information and data contained there are valid and replace the corresponding information in this user manual. Any contradictory information contained in this user manual thus becomes invalid. If you have any questions regarding special applications, please contact Gruetzner GmbH (chapter I.II).

The actual and factual operator must ensure and guarantee that these instructions, including any supplementary sheets, have been read and understood by all persons responsible for the installation, operation or maintenance of PRV. Therefore, keep these instructions in a suitable place, ideally in an easily accessible place in the surrounding area of PRV.

Inform your colleagues who work in the local area of the machine about safety instructions so nobody gets hurt.

This manual was written in German, all other language versions are translations of this manual.

1.1 Signal words

The following signal words are used in this manual to draw your attention to possible dangers, prohibitions and other important information:

DANGER

This signal word points you to an immediate and threatening risk of serious injury or death.

WARNING

This signal word indicates a potentially imminent danger which can result in serious injury or even death.

CAUTION

This signal word indicates a potentially imminent danger that can result in minor to severe injuries.

NOTICE



This signal word indicates a potentially imminent danger which can result in damage to property.

INFORMATION

This signal word refers to practical application tips or particularly important information when using PRV.

1.2 Warning symbols

The following warning symbols are used in this user manual to alert you to hazards, prohibitions and important information:

		
General warning sign	Electricity hazard	Flammable material



1.3 Structure of the safety instructions

The safety instructions in this user manual are structured according to the following system:

	CAUTION
	<p>This text explains the consequences of disregarding the reference.</p> <ul style="list-style-type: none">• This text shows what to do as an instruction.

1.4 Symbols for information

The following information symbols are used in the text and instructions in this manual:

-  Requests you to take action
-  Shows the consequences of an action
-  Additional information about the action

2. Safety

All persons working with PRV must follow these operating instructions, in particular the safety instructions and the rules and regulations applicable at the place of use. Generally applicable legal regulations and other rules as well as the relevant rules and regulations for accident prevention (e.g. personal protective equipment (PPE)) and environmental protection must be observed.

2.1 Hazards

In order to avoid danger to the user or damage to the machine on which the PRV is used, PRV may only be used for its intended purpose (chapter 2.4) and in a technically safe condition.

Always inform yourself about the general safety instructions (chapter 2.6) before starting to work.

2.2 Staff

Only qualified staff who has read and understood this manual may work with PRV. Local and/or company regulations apply accordingly.

2.3 Reasonably predictable misuse

Any use of PRV which exceeds the maximum permissible technical data is generally considered to be improper and therefore prohibited.

2.4 Usage for the intended purpose

The following points must be observed for the intended purpose of using PRV:

- PRV is exclusively approved for industrial use.
- PRV may be used in accordance with the technical data (chapter 3.4) exclusively.
- Unauthorized structural alterations to PRV are not permitted.
- Read the user manual and act accordingly.
- During operation of PRV, a visual inspection of PRV as well as of the lubrication point must be carried out regularly. Any anomalies must be eliminated immediately and the cause must be rectified.
- PRV may not be opened or disassembled.
- Only lubricants approved by Gruetzner GmbH may be used.
- Relevant regulations and rules on work safety, accident prevention and environmental protection must be observed.
- Work and activities with and on PRV are only permitted with appropriate authorisation (chapter 2.2).

All other uses than the aforementioned intended usage or the disregard of one of the above points shall be deemed improper usage. In this case no liability and/or warranty is assumed.





2.5 Warranty and Liability

If the following items are disregarded, all warranty and liability claims for personal injury and/or damage to property are excluded in case of:

- non-observance of the instructions on transport and storage;
- misuse;
- improper or unperformed maintenance or repair work;
- improper assembly / disassembly or improper operation;
- operation of PRV with defective protective devices;
- operation of PRV without lubricant;
- operation of PRV with non-approved lubricant;
- operation of heavily contaminated PRV;
- modifications or alterations have taken place which were carried out without the written permission of Gruetzner GmbH;
- opening and/or partial or complete disassembly of PRV.

2.6 General safety instructions

The following safety instructions are given for PRV:

	<p style="text-align: center;">NOTICE</p> <p>Loose or overloaded screw connections can cause damage to PRV.</p> <ul style="list-style-type: none">• Mount and check all screw connections with the permissible torques specified for this purpose. Use a calibrated torque wrench.
	<p style="text-align: center;">WARNING</p> <p>Lubricants are flammable.</p> <ul style="list-style-type: none">• In case of fire do not use a water jet to extinguish.• In case of fire only use suitable extinguishing agents such as powder, foam and carbon dioxide.• Observe the relevant safety instructions of the lubricant manufacturer on the safety data sheet of the lubricant used.
	<p style="text-align: center;">CAUTION</p> <p>Lubricants can cause skin irritations.</p> <ul style="list-style-type: none">• Avoid direct skin contact.
	<p style="text-align: center;">NOTICE</p> <p>Lubricants can contaminate soil and water.</p> <ul style="list-style-type: none">• Use and dispose lubricants properly.

Progressive distributors

3. Description of function

3.1 General information

PRV is used to reliably supply multiple lubrication points in machines and systems with oil (>ISO VG 100) or grease (up to NLGI cl. 2). The lubricant supplied by a pump is divided in subsets according to the number of outlets of PRV and is delivered to the lubrication points.

The number of outlets and their delivery rates are defined by the design for PRV standard distributors described below. On request, various special distributors are available.

PRV is a progressive lubricant distributor for a maximum working pressure of 100 bar (1,450 psi). It is therefore particularly suitable for use with lubricant pumps of the Gruetzner Lubricus series.

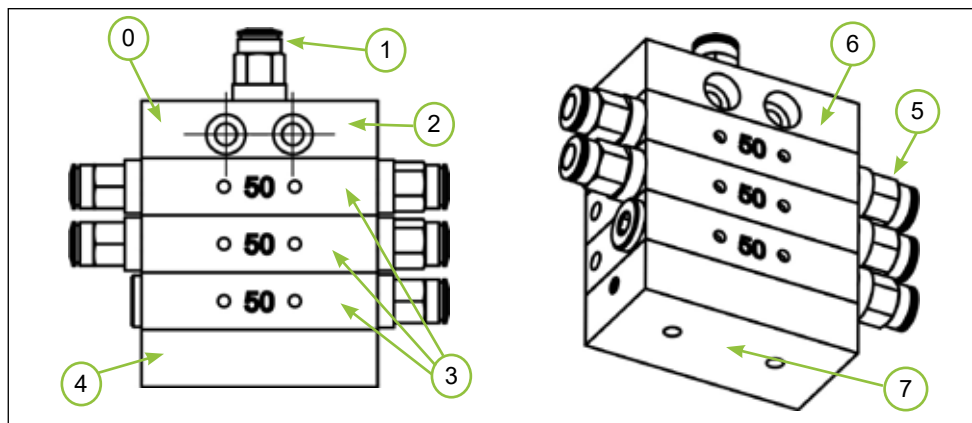

Fig. 1: Overview PRV 5-50

<i>No.</i>	<i>Description</i>
0	PRV
1	Lubricant inlet
2	Initial element
3	Dispensing elements
4	Final element
5	Lubricant outlets
6	Through holes for mounting
7	Nameplate with serial number

3.2 Identification

A sticker informs about the serial number (which serves the traceability of PRV). It is visibly attached to PRV itself. For the position of the sticker and the serial number, please refer to chapter 3, fig.1.

3.3 Scope of delivery

PRV is available in several different versions. They differ in the number of outlets and by the characteristics of the dispensing elements.

All versions of the PRV are prefilled with a neutral, food-grade (H1) lubricant (approx. 3 cm³) which can be mixed with the lubricants approved by Gruetzner GmbH to simplify the initial commissioning. The manufacturer's designation is Addinol Foodproof XHF 150 S. Further data and documentation on the lubricant Addinol Foodproof XHF 150 S are available on request from Gruetzner GmbH.

Progressive distributors

3.4 Technical data

General			
Tube connector inlet/outlet		straight for tube $\varnothing = 6 \text{ mm}$ / M10x1 special tube connectors on request	
Mounting options		2 blind holes in the initial element for cylinder head screw M5 (DIN 912)	
Max. torque mounting		3	Nm
Mounting position		horizontal movement direction of the delivery pistons	
Material main body		aluminum	
Material grease inlet/outlet		CuZn39Pb3	
Operating temperature		-20 ... +70*	°C
Lubricant and hydraulic			
Lubricant characteristics**		grease	up to NLGI class 2
		oil	minimal viscosity ISO 100 VG
Number of outlets		2 to 10	
Hydraulic connection		directly or via PA tube	
max. pressure		100	bar
max. inlet volume flow		0.5	ml/s
Grease delivery per piston stroke	Dispensing element 50	0.050	ml
max. length connection line to inlet		300	mm

* In individual cases the operating temperature may depend on other factors (e.g. lubricant).

** Warranty is only given when using lubricants with Gruetzner approval.

Progressive distributors

The following sketch shows the outer dimensions of PRV-3. The length L of each standard distributor can be found in table 1.

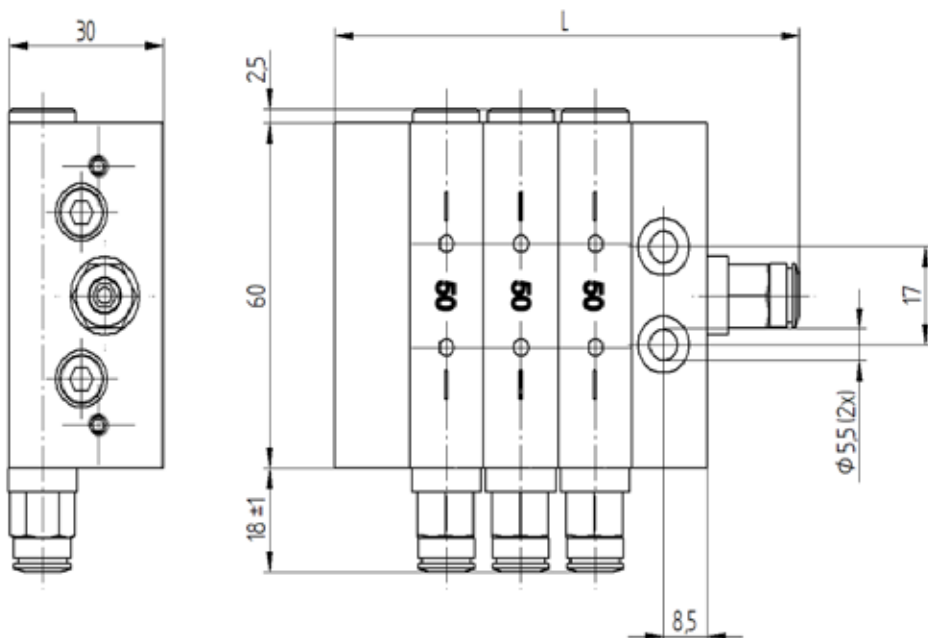

Fig. 1: Sketch PRV-3

Art. no	Width (mm)	Length (mm)	Weight (g)	Total no. of outlets	No. of right outlets	No. of left outlets
PRV-2	96	95	476	2	1	1
PRV-3	81.5	95	476	3	3	0
PRV-4	96	95	476	4	3	1
PRV-5	96	95	476	5	3	2
PRV-6	96	95	476	6	3	3
PRV-7	96	109,5	567	7	4	3
PRV-8	96	109,5	567	8	4	4
PRV-9	96	124	657	9	5	4
PRV-10	96	124	657	10	5	5

Table 1

3.5 Special distributors

Any PRV that has been developed in direct consultation with the customer and is not documented in Table 1 is considered a special distributor.

Special distributors are PRV whose output quantities per outlet are different from each other, or which enable higher output quantities than the standard distributors or whose hose connectors contradict the standard.

4. Transport and storage

4.1 Packaging

PRV is delivered in an outer packaging (cardboard box). To protect them from moisture and dirt, they are also packed in PE films. As a preventive measure to stop the prefilled lubricant escaping from PRV, a dowel pin is inserted in the inlet hose connector.

Dispose the packaging materials at the designated disposal points in compliance with the relevant national and company regulations.

After receiving PRV check the delivery note for completeness and correctness.

Any missing parts or damage must be reported immediately to the forwarding agent, the insurance company or Gruetzner GmbH in writing.

4.2 Transport

NOTICE	
	<p>Hard shocks due to e.g. falling or setting down too hard can damage PRV.</p> <ul style="list-style-type: none">• Do not throw PRV.• When using lifting equipment only use hoists and load handling attachments in perfect condition and with sufficient load capacity.• The permissible lifting weight of the lifting device must not be exceeded.

4.3 Storage

Store PRV in its original packaging in a vertical position in a dry, frost-free environment at an ambient temperature of +5 °C to +30 °C. The maximum storage time in unopened condition is 2 years.

The so-called "first-in-first-out" principle (fifo) is recommended for storage logistics.

5. Mounting

5.1 Preparations

Before starting to work, inform yourself in detail about PRV using this user manual and follow the general safety instructions (section 2.6) in particular. Prepare the installation site carefully.

	NOTICE
	<p>Pressurised air can damage the seals of PRV and can transport dirt and foreign matter into PRV or the lubricant.</p> <ul style="list-style-type: none">• Do not use pressurised air.• Make sure that there is no coarse dirt in the mounting area.

5.2 Mounting

1	<p>Condition as delivered</p> <p>PRV is delivered sealed in PE film in a cardboard box.</p>
---	--

2	<p>Pull out the sealing dowel pin</p> <p>✦ Pull the dowel pin out of the top of the PRV lubricant inlet.</p> <ul style="list-style-type: none">ⓘ Make sure that no dirt, water or foreign bodies enters the lubricant inlet.ⓘ As soon as the dowel pin is removed from the lubricant inlet, lubricant can leak out. Do not turn the distributor!
---	--

3

Mount the progressive distributor

✦ Pull the dowel pin out of the top of the PRV lubricant inlet.

- ⓘ Mount the PRV carefully according to the steps described in chapter 3.4.
- ⓘ Ensure a flat support surface when mounting PRV.

4

Hydraulic connection: inlet

✦ Connect the lubricant supply to the inlet of PRV.

- ⓘ Pay attention to cleanliness when carrying out the work. It is imperative that dirt and foreign bodies do not enter the pipes or the distributor.
- ⓘ Ideally, use tubes prefilled with the appropriate lubricant.

5

Flushing the distributor

✦ Activate the lubricant supply until the lubricant you are using emerges from all outlets of the progressive distributor.

- ⓘ Dispose the lubricant that has escaped from the distributor.

6

Hydraulic connection: outlets

✦ Connect the outlets of the distributor to the respective connecting lines.

ⓘ Pay attention to cleanliness when carrying out the work. It is imperative that dirt and foreign bodies do not enter the pipes or the distributor.

ⓘ Ideally, use tubes prefilled with the appropriate lubricant.

ⓘ Use connecting lines with the same cross section at each outlet.

7

Flushing the connection lines

✦ Activate the lubricant supply you are using until the lubricant you are using emerges from all connecting lines.

ⓘ If you have used connecting lines that are prefilled with the lubricant you are using, this step is not necessary.

8

Hydraulic connection: lubrication point

✦ Fit the connecting lines to the lubrication points.

5.3 Commissioning

Mount PRV carefully according to the steps described in chapter 5.2.

Depending on the scope of delivery you must also carry out the following additional measures for the first commissioning:

1. Check the assembly

Ensure that PRV is properly and completely assembled. In particular, the connections between the pump and the distributor or between the distributor and the lubrication points must be properly connected.

2. Check the output of the pump used

Make sure that the set output of the lubricant supply matches the lubrication requirements of the individual lubrication points. If this is not the case, adjust the delivery rate accordingly.

	CAUTION
	<p>If special PRV are connected incorrectly, lubrication points can be under-lubricated or over-lubricated and thus cause damage to machine elements.</p> <ul style="list-style-type: none">• Ensure that the connecting cables are connected correctly before commissioning. Mark them if necessary.

5.4 Operating

In the interest of dispensing accuracy it must be ensured that the delivery pistons fulfil at least two complete circulations during each lubrication process.

When using PRV with the lubricant pumps of the Lubricus series ensure the number of delivery cycles mentioned in the following table are executed.

Number of dispensing elements	Recommended minimum number of strokes of a Lubricus
3	5
4	6
5	7
6	8
7	10

Please note the following when operating the progressive distributor:

➡ When delivering lubricant is forced, the blockage of a single lubrication point leads in blocking the entire progressive distributor. Controlled lubrication of the lubrication points is no longer guaranteed.

Progressive distributors

The following applies to the lubricant supply of the lubrication points connected to the PRV when using the standard PRV mentioned in Table 1, section 3.4:

Each outlet is supplied with the same lubricant and the same quantity of lubricant during a lubrication interval (=inserting enough lubricant into PRV that theoretically each outlet delivers lubricant once).

5.5 Troubleshooting

If lubricant is fed into PRV but is not delivered to the lubrication point, the following scenarios may have occurred:

Possible Error	Remedy
Blockage of one or more lubrication points	Check the lubrication points, disconnect the hoses
Internal blockage of PRV	Check the function of the distributor, disconnect the hoses
Leak in a connecting line	Check the connecting lines from the lubricant supply to the PRV and from the PRV to the lubrication points

If you cannot detect a blockage at a lubrication point and ensure that the PRV is fed with lubricant, contact Gruetzner GmbH.

6. Maintenance and disposal

- Before starting any maintenance work, inform yourself about the general safety instructions (see chapter 2) and observe the relevant local and operational safety regulations.
- Do not deactivate any protective device without authorization!

6.1 Maintenance schedule

The following maintenance schedule must be observed for PRV:

Maintenance	Commissioning	After 3 months	Annually	If required
Cleaning	x	x	x	x*
Visual check	x	x	x	x*

* Depending on operating conditions and lubricant consumption

6.1.1 Visual check

- Check the entire lubrication system incl. PRV for external damage (e.g. loose or loosened tubes) by a thorough and conscientious visual inspection.
- Check the condition of the lubrication point for correct supply of lubricant.
- Replace damaged or defective parts immediately to ensure permanent lubrication.

6.1.2 Cleaning

- Clean PRV from dirt using suitable cleaning agents (e.g. absorbent towels, cloths).

	NOTICE
	<p>Compressed air can damage the seals of PRV as well as transport dirt and foreign bodies into PRV or the lubricant.</p> <ul style="list-style-type: none"> • Do not use compressed air to clean PRV.

6.1.3 Recommissioning after maintenance

- Reinstall all safety devices and make sure that no tools remain in the danger area.

6.2 Disposal

- When disposing PRV observe the relevant national regulations in force.
- When disposing PRV observe the relevant safety data sheets and disposal instructions for the individual components.

7. Released accessories

7.1 Lubricants

Only use lubricants approved by Gruetzner GmbH.

7.2 Tube lengths

In principle it is recommended to mount PRV as close as possible to the lubricant supply and to keep the distance between PRV and the lubrication points as small as possible.

If you cannot mount the PRV directly or at the specified distance (chapter 3.4) to the lubricant supply, contact Gruetzner GmbH to verify your application. The influence of temperature, the grease, the hoses and accessories used does not allow a general statement to be made about the possible hose length on PRV.

Progressive distributors

8. Appendix

8.1 Dimension sheet and installation dimensions

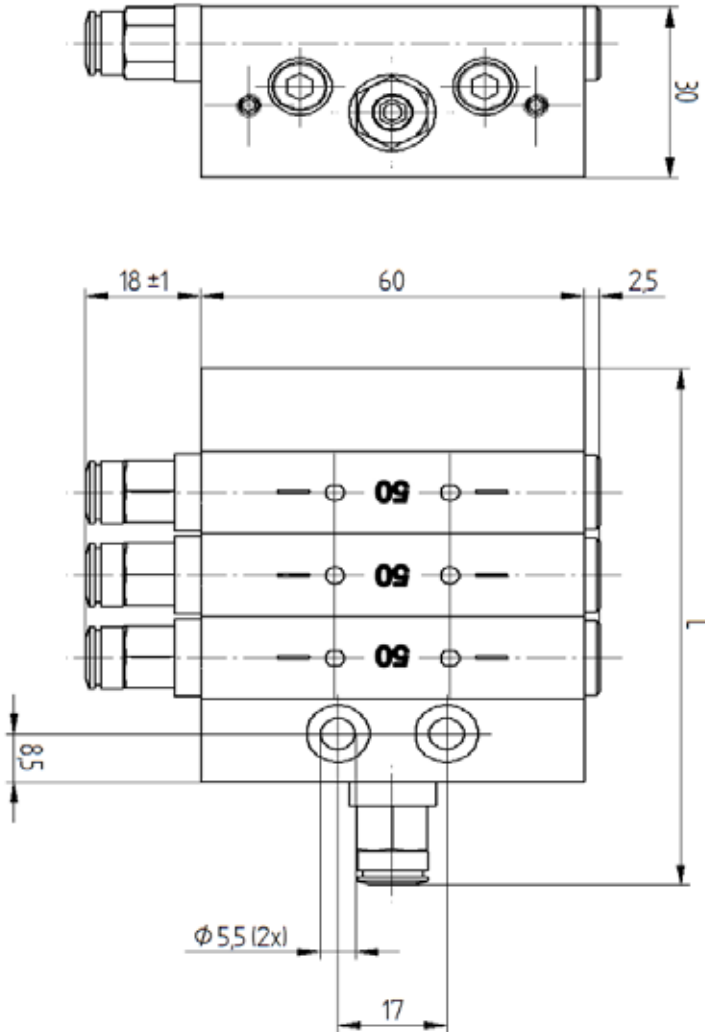

8.2 Drilling pattern for PRV

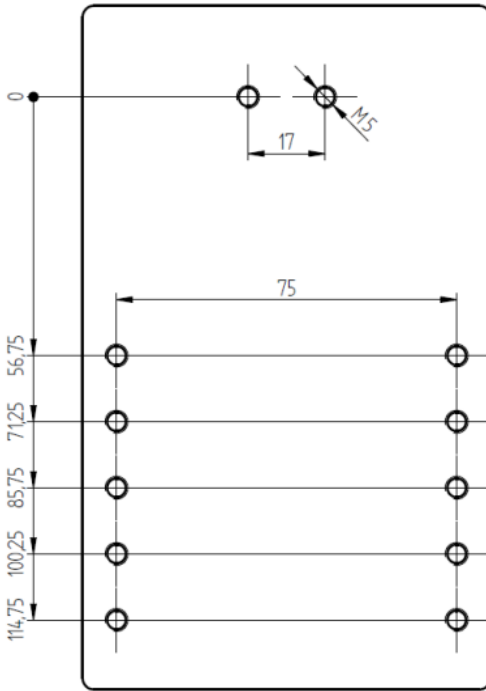



GRUETZNER
AUTOMATIC LUBRICATION



G | LUBE



SOLO LUBE

AUTOMATIC LUBRICATION



LUB 5



LUBRICUS

Gruetzner GmbH

Dagobertstr. 15 • D - 90431 Nuremberg, Germany

Tel. +49 911 277 399 0 • info@G-LUBE.com • www.G-LUBE.com