

## 6. Refilling



Remove the lid of the oil reservoir and fill it up to the 480 ml level with oil.



Reset the device after refilling (see „5.6 Reset“) and then set the dispensing quantity again.

## 7. Cable assignment

Please only use the connection cable supplied.

Colour	Assignment
black	Power connection (9 - 24 V DC)
blue	Ground (GND)
brown	Input signal (24 V DC)
white	Output signal

## 8. Input / output signals

### 8.1 Input signal

A dispense is triggered by a **signal (HIGH 24 V DC)** with a length of **2 seconds** from the PLC. A **pause of 5 minutes** must be observed between two signals from the PLC. The pause ensures that the device does not overheat.

### 8.2 Output signals

An output signal can be tapped at PIN 2 (white). A permanent HIGH signal is sent for the status message **"Running time ended"**. A square-wave signal (alternating 4.75 sec. HIGH and 0.25 sec. LOW) is sent for the status message **"Back pressure too high"**.

## 9. Dispensing quantity

You can set the number of strokes per dispensing on the device. 0.34 ml are dispensed per stroke.

Set value	1	2	3	4	5	6
Quantity per dispensing in ml	0.34	0.68	1.02	1.36	1.70	2.04

## 10. Mounting

**Direct mounting** is always preferred.

If the application does not allow direct mounting, remotely assemble the unit using appropriate accessories and keep the distance from the lube point as short as possible.

For **remote installations** use a 4 mm (inner diameter) tube pre-filled with the same or compatible oil as the oil contained in the unit.



**Multiple point installation** is possible using a progressive distributor. Do not block any connections to the progressive distributor. Instead use a suitable distributor in accordance with the number of lubrication points. Keep the distance between the distributor and the lubrication unit as short as possible.

## 11. Important information

- The lubricant dispenser is **not** suitable for use with grease.
- Minimize tube resistances. Narrow passages and right angles should be avoided.
- During operation of the device a visual inspection of the device as well as of the lubrication point must be carried out regularly.
- Product warranty is limited to original defects in material and workmanship and does not cover any collateral damage due to mishandling, abuse and/or any other inappropriate use of the device.
- The maximum storage temperature should not exceed +40 °C (+104 °F). Higher temperatures decrease the lubricants lifespan. The lubricator has to be activated within two years from receiving.

## 12. Status messages



**Blank LCD screen**

**Cause:**

Electrical fault in the CPU or the power circuit

**Remedy:**

Check the power supply. Press the RESET button to restart the lubricator. If the problem persists, contact your supplier.



**Dispensing time expired**

When the running time of the lubricator has ended, the illuminated display starts to flash.

**Remedy:**

Refill the oil reservoir.

(see „6. Refilling“).



**Excessive back pressure**

If the back pressure is too high, 0 appears and the illuminated display starts to flash.

**Remedy:** Start the test mode

When the display stops flashing and 0 disappears, the appliance switches to operating mode. No further action is required. If the display continues to show 0, check the back pressure at the lubrication point and the lines. The lubrication point may be blocked and/or the hose length may be too long. If the problem persists, please contact your supplier.



**Display error on LCD screen**

**Cause:**

Electrical fault in the CPU or the power circuit

**Remedy:**

Press the RESET button to restart the lubricator. If the problem persists, contact your supplier.

# G LUBE EM D OIL

## User manual GL-EM-D-OIL



## 1. Product details

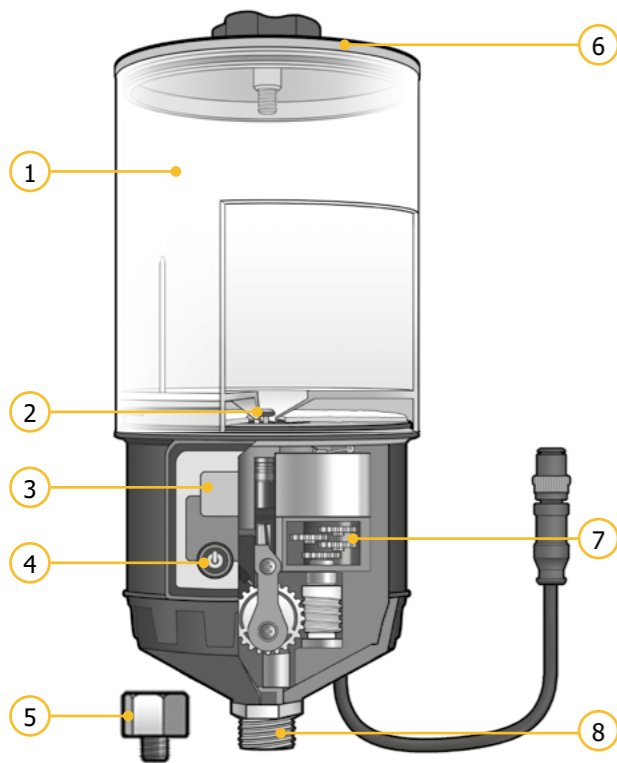

No.	Description	No.	Description
1	Oil reservoir	5	Reducer 3/8" x 1/4"
2	Return valve	6	Cover for oil reservoir
3	Display	7	Drive
4	Dispensing setting	8	Thread male 3/8"

## 2. Technical data

Housing		
Operating temperature	-20 ... +60*	°C
Dimensions (height x Ø)	229 x 94	mm
Lubricant and hydraulic		
Lubricating medium	oil (> ISO VG 10)	
Lubricant volume	480	ml
Number of lubrication points	up to 12 (with progressive distributors)	
Max. operating pressure	10	bar
Oil delivery	per stroke	0,34 ml
Oil quantity per dispensing	0,34 - 2,04 ml	

Electrics		
Working voltage (DC)	9 ... 36	V
Protection class	IP65	

\* The stated value is down to the individual application and may extensively differ in some cases (depending on the lubricant and further conditions).

## 3. LCD & key assignment

Key assignment	
	POWER: Switch device on and off PURGE: start test mode
	LOCK: Unlock device MODE: Set dispensing quantity (number of strokes per dispensing) RESET: Reset to default setting (in the event of a malfunction or after refilling)
	Backlight ON: Press and hold  and press .

LCD-display	
	Number of strokes per dispensing set
	Device locked
	Operating mode
	Test mode
480	Oil reservoir capacity

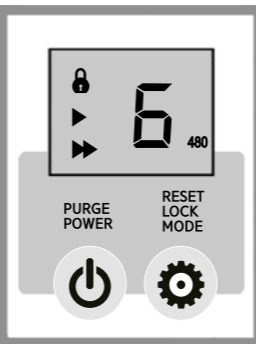

## 4. Installation



Ensure that a thorough pre-lubrication of the application is carried out before activating the lubricator.



If the lubricator is installed below the lubrication point, make sure that the lubrication lines are filled.

**NOTE** The oil in the equipment (hose/feed lines) and the oil in the unit should be the same or compatible.



Remove the lid of the oil reservoir and fill it up to the 480 ml level with oil.

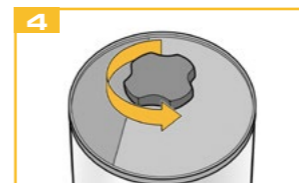

Turn the knob 1-2 turns counterclockwise before closing the cover and do not change the position again during operation.



Fix the lubricator in the desired position.

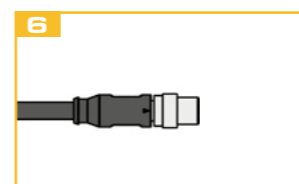

Connect the device to a PLC using the enclosed connection cable. (see „7. Cable assignment“).

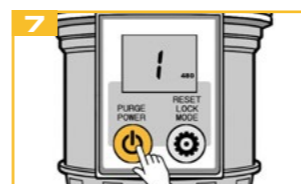

Keep pressed for 5 seconds to switch on the device.



While the displayed months are flashing, press repeatedly until the desired dispensing time appears in the display.

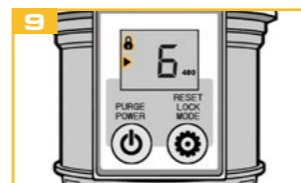

Wait for 7 seconds. The key lock is now activated and the lubricator is ready for operation ( and appear in the display).

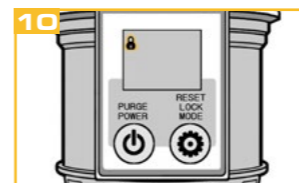

After a short time, the device switches to sleep mode. Only the symbol is shown on the display.

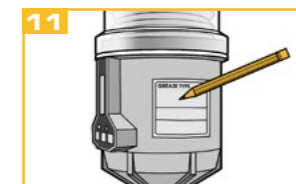

Note the installation and due date on the drive unit.

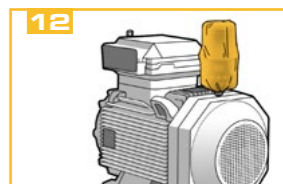

Pull the dust protection cover over the lubricator where necessary.

## 5. Operation and settings

### 5.1 Switch on/off

Deactivate the key lock. Press and hold for 5 seconds to switch the lubricator on or off.

### 5.2 Exit sleep mode

If only the symbol is shown on the display, the device is in sleep mode between two donations. Press and hold for 5 seconds to exit sleep mode.

### 5.3 Key lock

The symbol in the display shows the activated key lock. The key lock is automatically activated as soon as there is no key operation for 7 seconds. Press and hold for 3 seconds to deactivate the key lock. The symbol disappears.

### 5.4 Switch on the display backlight

Deactivate the key lock. Press and hold and press . The display backlight is activated for 5 seconds.

### 5.5 Change dispensing quantity setting

The set dispensing quantity can be changed at any time during operation. Deactivate the key lock. Press and hold for 3 seconds until disappears. Then keep pressing until the desired dispensing quantity is reached.

### 5.6 Reset

To reset the unit to the default settings, deactivate the key lock and press and hold for 5 seconds. The display lights up briefly and then goes out. The lubricator is now switched off.

### 5.7 Start test mode

The test mode is suitable for testing the function of the lubricator or for filling lines and connecting parts with grease. Deactivate the key lock. Press and hold for 3 seconds until and appears on the display. The test mode is now activated, 6 lubrication cycles are triggered (6x 0.34 ml).

### 5.8 Stop test mode

Deactivate the key lock. Press once while the device is running in test mode. After the current lubrication cycle is finished, disappears and the lubricator goes back into normal operation.